

# EQUIPMENT



**NEXT**

## **Adhesives**

Conductive .....	4
Epoxy .....	336
General Purpose .....	335
Heatsink .....	4, 335
Quick-Bond Gel & Accel.....	336
Super 77 Spray .....	332
<b>Anti-Static Equipment.....</b>	<b>333, 335</b>

## **Battery Backup Systems .....**

.....	350
<b>Breadboards .....</b>	<b>341, 342</b>

## **Chemicals**

### **Accessories**

Adhesive .....	4, 335
Wipes .....	334
Circuit Chiller .....	335
Cleaners .....	334, 335
Defluxers .....	334
Developer Concentrate .....	336
Dry Etchant.....	337
Etch Resist Sensitizer .....	336
Isopropyl Alcohol .....	334
Liquid Etchant.....	337
Lubricants .....	334
Printed Circuit Materials .....	336
Printed Circuit Repair Kit.....	336

## **Chemicals (cont.)**

Protective Coatings .....	335
Silver Epoxy Kit .....	336
<b>Circuit Boards .....</b>	<b>337-339</b>
<b>Clamps .....</b>	<b>330</b>
<b>Cordgard .....</b>	<b>350</b>

<b>Drafting Aids .....</b>	<b>337</b>
<b>Drills .....</b>	<b>322</b>

<b>Etching Supplies .....</b>	<b>336, 337</b>
<b>Extender Cards.....</b>	<b>338, 339</b>
<b>Eyelets .....</b>	<b>321</b>

<b>Flashlight .....</b>	<b>347</b>
<b>Flux, Solder .....</b>	<b>331</b>
<b>Frequency Counter .....</b>	<b>343</b>

## **Generators .....**

## **Jumper Wire .....**

## **Kits**

Electronic Tool.....	328
Field Service Kit .....	333
Staking .....	321
Tool Sets .....	224-226
Wire Jumper .....	341

## **Kits (cont.)**

Wire Sorter .....	347
-------------------	-----

## **Line Conditioners .....**

## **Lubricants**

Cleaner-Lubricant.....	334, 335
Silicone Grease .....	335

## **Multi-Purpose Tool.....**

## **Oscilloscopes .....**

## **Outlet Strips.....**

## **PC Boards**

Copper Clad .....	310
Plug Boards.....	337-339
Prototyping Grid .....	337

## **PCB Accessories**

Card Guides .....	306
Drafting Symbols .....	337
Etching Solution Heater .....	336
Multi-Mod Case .....	340
Pad Cutter .....	340
Pins and Terminals .....	340
Power Etching System .....	336
Solder Eyelets .....	340
Tefzel Silver Plated Wire.....	340
Toner Transfer System .....	336

**Main  
Menu**

**New  
This Issue**

**Products**

**Vendors**

**Service**

**Spec  
Sheets**

**Help**



# EQUIPMENT



## PCB Accessories (cont.)

Wire-Wrap Tool .....340

## Pens

Conductive .....336

Etch Resist .....336

Marking .....74, 332

Overcoat .....336

**Plug Boards** .....337-339

## Power Conditioning Equipment

Console Surge Protector .....348

Dataline Protectors .....348

DC to AC Inverters .....348

Fax Modem Protectors .....348

Line Conditioners .....349

Omnipower UPS .....349

SMART Series UPS .....349

Surge Suppressors .....348, 350

UPS Systems .....349, 350

**Power Cords** .....93

**Power Strips** .....350

**Presses & Accessories** .....318, 323

**Prototype Boards** .....337-342

## Punch

Boards .....338

Drivers .....320

Sets .....319, 320

## Punches

Circular .....319

Connector .....320

Knockout .....321

Panel .....320

Rectangular .....319

## Software

Circuit Simulator .....342

Cross Reference .....25

PCB Design .....336

Power Alert UPS Shutdown .....349

## Solder Products

Flux-Pen .....331

Liquid Rosin Flux .....331

## Solder

Bar .....331

Flux Core .....331

Paste .....331

Rosin Core .....331

Solid Wire .....331

Water Soluble Core .....331

VOC Free Flux .....331

## Soldering Aids

Desoldering Braid .....331

Desoldering Tools .....329, 330

Heat Gun .....330

## Soldering Aids (cont.)

Seizer Clamps .....330

## Soldering

Irons .....328-330

Guns .....329

Stations .....328, 329

Tips .....328, 329

Soldering Aid Set .....330

## Static Control Products

Anti-Stat .....335

## Static Control Products (cont.)

Anti-Static Freezer .....335

Cleaners .....334, 335

Conductive Foam .....333

Field Service Kit .....333

Floor Mat .....333

Hand Lotion .....335

Labels .....333

Shielding Bags .....333

Table Mats .....333

Wrist Strap .....333

**Surge Suppressors** .....348, 350

**Tap and Die Set** .....322

## Test Equipment

Accessories .....342-347

Circuit Tracer .....347

Main Menu

New This Issue

Products

Vendors

Service

Spec Sheets

Help



# EQUIPMENT



## Test Equipment (cont.)

Counter-Timer .....	342
Frequency Counters.....	342, 343
Function Generators .....	342-344
Logic Probes .....	346
Multimeters, Digital.....	343, 345, 346
Oscilloscope Probe Set.....	343
Oscilloscopes .....	343, 344
Power Supplies, DC .....	342, 344
Pulse Generator .....	342
Resistor Decade Box .....	199
Wire Sorter Kit.....	347
Voltage/Continuity Tester .....	347
Voltage Indicator .....	347
VOMS.....	347
<b>Tool Cases .....</b>	<b>347</b>

<b>Uninterruptible Power Supply (UPS System).....</b>	<b>349, 350</b>
---	-----------------

<b>Vacuum .....</b>	<b>347</b>
<b>Vises .....</b>	<b>323, 337</b>

## Manufacturers:

3M .....	332, 333, 341, 347
B&K Precision .....	344, 345
Bishop Graphics .....	337
Circuit Works .....	336, 350
Clarostat .....	199
GC Electronics .....	336, 350
Global Specialties.....	342
Greenlee .....	320, 321, 347
Isotip .....	322, 329
Kester .....	331
Keystone .....	320, 321
LG Precision.....	343
NTE .....	25, 336
Panavise.....	326
Platt .....	347

## Manufacturers: (cont.)

PSP .....	341
Simpson .....	347
Soder-Wick.....	331
Tech Spray.....	331, 334, 335
Tripp Lite .....	348, 349
Ungar.....	330, 331
Vector.....	338-340
Waber .....	350
Wavetek .....	346
Weller .....	328, 329
Xacto.....	341
Xcelite.....	330

Main Menu

New This Issue

Products

Vendors

Service

Spec Sheets

Help

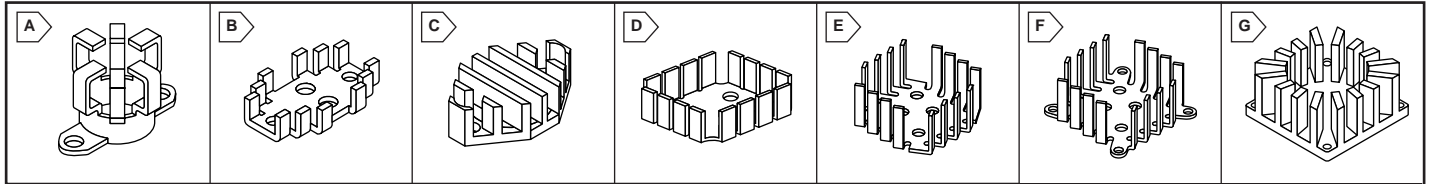

## HEAT SINKS

MOUSER STOCK NO.	Fig.	Description	Ther Res (°C/W)	Dimensions (In.)			Price Each			
				L	W	H	1	10	100	500
<b>For TO-3 Case Styles</b>										
532-579103B00	A	Space saving, expandable collar	22.0	1.540	1.125	.870	.75	.67	.57	.48
532-575603B00	B	Space saving, slanted fin basket	15.6	1.630	1.290	.500	.79	.70	.59	.50
532-575703B00	B	Space saving, slanted fin basket	13.4	1.630	1.290	.750	.77	.69	.58	.49
532-575803B00	B	Space saving, slanted fin basket	11.0	1.630	1.290	1.000	.96	.85	.72	.61
532-575903B00	B	Space saving, slanted fin basket	9.8	1.630	1.290	1.250	1.04	.92	.78	.66
532-542303X00	C	Space saving, cap cover	16.4	1.610	1.062	0.500	3.07	2.73	2.31	1.96
532-542603X00	C	Space saving, cap cover	15.2	1.610	1.062	0.750	3.30	2.93	2.49	2.10
532-542703X00	C	Space saving, cap cover	12.8	1.610	1.062	1.000	4.19	3.71	3.15	2.66
532-501303B00	D	Space saving, minimal board space	12.0	1.880	1.400	0.500	.70	.62	.52	.44
532-501403B00	D	Space saving, minimal board space	10.0	1.880	1.400	0.750	.74	.65	.55	.47
532-501503B00	D	Space saving, minimal board space	8.4	1.880	1.400	1.000	1.02	.91	.77	.65
532-501603B00	D	Space saving, minimal board space	7.8	1.880	1.400	1.250	1.16	1.03	.87	.74
532-576103B00	E	Slanted vanes for maximum cooling	7.2	1.810	1.810	0.500	.77	.68	.57	.49
532-576203B00	E	Slanted vanes for maximum cooling	6.2	1.810	1.810	0.750	.88	.78	.66	.56
532-576303B00	E	Slanted vanes for maximum cooling	6.0	1.810	1.810	1.000	1.09	.97	.82	.69
532-500103B00	F	Slanted fins for efficient cooling	7.2	1.810	1.810	0.500	1.71	1.52	1.29	1.09
532-500203B00	F	Slanted fins for efficient cooling	6.2	1.810	1.810	0.750	2.70	2.39	2.03	1.72
532-500303B00	F	Slanted fins for efficient cooling	5.8	1.810	1.810	1.000	1.57	1.39	1.18	1.00
532-500403B00	F	Slanted fins for efficient cooling	5.0	1.810	1.810	1.250	1.20	1.07	.91	.77
532-568303B00	G	Natural or forced air cooling	5.4	1.810	1.810	1.250	3.97	3.52	2.99	2.53
532-569003B00	H	Fold-back fins for maximum surface	5.4	1.830	1.830	1.310	1.15	1.02	.87	.73
<b>For TO-66 Case Styles</b>										
532-579206B00	A	Expandable collar heat sink	22.0	1.225	0.812	.540	.78	.69	.59	.50
532-569006B00	H	Fold-back fins for maximum surface	5.4	1.830	1.830	1.310	1.32	1.17	1.00	.84
<b>For TO-5 Case Styles</b>										
532-323005B00	I	Finned for maximum thermal cooling	56.0	0.750	0.750	0.250	.93	.82	.70	.59
532-578205B00	J	Snap-on cooler for easy assembly	38.0	0.750	0.830	0.395	.22	.20	.17	.14
532-578305B00	J	Snap-on cooler for easy assembly	35.0	0.750	0.830	0.395	.26	.23	.20	.17
<b>For TO-18 and TO-92 Case Styles</b>										
532-322400B00	K	Space saver, easy installation	100.0	0.500	0.500	0.235	.67	.59	.50	.42
<b>For TO-92 Case Styles</b>										
532-575200B00	L	Slip-on, low cost, minimum space	60.0	---	0.602	0.720	.23	.21	.17	.15
532-575400B00	L	Slip-on, low cost, minimum space	40.0	---	0.602	1.220	.24	.22	.18	.15
<b>For TO-126 and TO-127 Case Styles</b>										
532-577500B00	M	Vertical mount for easy assembly	26.0	0.520	0.775	0.320	.26	.23	.19	.16
532-507302B00	N	Economy, low profile	24.0	0.750	0.750	0.375	.18	.16	.14	.12
<b>For TO-202 Case Styles</b>										
532-576904B00	O	Trim, low profile, minimum space	32.0	0.750	0.520	0.250	.26	.23	.19	.16
532-577304B00	O	Trim, low profile, minimum space	27.2	0.750	0.520	0.375	.24	.22	.18	.15
532-577404B00	O	Trim, low profile, minimum space	24.0	0.750	0.520	0.500	.25	.22	.18	.15
532-574204B00	P	Clip-on cooler for easy assembly	16.8	0.390	1.020	0.900	.25	.22	.19	.16
532-531002B25	Q	Extruded for HD application, solid pins	13.6	0.500	1.380	1.000	1.03	.91	.78	.66
532-531102B00	Q	Extruded for HD application, no pins	11.0	0.500	1.380	1.500	1.24	1.10	.94	.79
532-531102B25	Q	Extruded for HD application, solid pins	11.0	0.500	1.380	1.500	1.08	.96	.82	.69
532-531202B00	Q	Extruded for HD application, no pins	9.0	0.500	1.380	2.000	1.12	.99	.84	.71
532-531202B25	Q	Extruded for HD application, solid pins	9.0	0.500	1.380	2.000	1.16	1.03	.87	.74
532-531302B00	Q	Extruded for HD application, no pins	8.0	0.500	1.380	2.500	1.10	.98	.83	.70
532-531302B25	Q	Extruded for HD application, solid pins	8.0	0.500	1.380	2.500	1.20	1.06	.90	.76
<b>For TO-218 Case Styles</b>										
532-530101B10	R	Versatile high rise, twisted fins	16.8	0.500	1.750	1.750	1.04	.92	.78	.66
532-530101B15	R	Versatile high rise, twisted fins	16.8	0.500	1.750	1.750	1.47	1.30	1.11	.93
532-530401B15	S	Versatile high rise, staggered fins	16.8	0.750	1.750	1.750	1.47	1.30	1.11	.93
532-513102B25	T	Solder pins for solder mounting	11.0	0.500	1.380	1.500	.91	.81	.69	.58
532-513201B25	T	Solder pins for solder mounting	9.0	0.500	1.380	2.000	.95	.84	.72	.61
532-529801B25	U	Solder pins for solder mounting	5.0	1.000	1.650	1.500	1.30	1.15	.98	.83
532-592201B34	V	Clip-on with fold back fins	6.8	0.470	1.950	1.970	1.00	.88	.75	.63

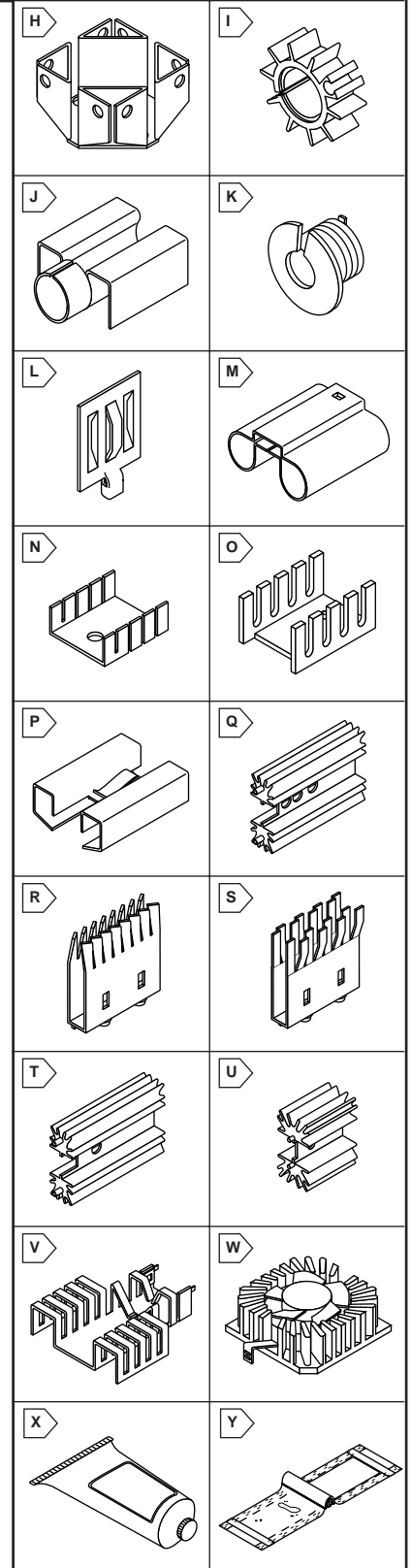

## HEAT SINK ASSEMBLIES FOR PENTIUM CPUs

MOUSER STOCK NO.	Fig.	Description	Dimensions (In.)			Price Each			
			L	W	H	1	25	100	1000
532-355452F267	W	Heat sink and fan for pentium CPU with clip	1.960	1.960	0.650	16.98	15.28	13.58	11.89
532-355455F267	W	Heat sink and 12V fan for pentium CPU with clip	1.960	1.960	0.650	16.98	15.28	13.58	11.89

## THERMALLY CONDUCTIVE ADHESIVE AND COMPOUND

MOUSER STOCK NO.	Fig.	Description	Ther Res (°C/W)	Dielectric Strength	Thermal Conductivity	Price Each			
						1	10	100	500
532-100500F00	X	Thermally conductive compound	5 oz.	250	5.2	22.50	19.94	16.94	14.32
532-161000F00	Y	2-part thermally conductive adhesive	10 g	410	6.1	9.03	8.01	6.80	5.75





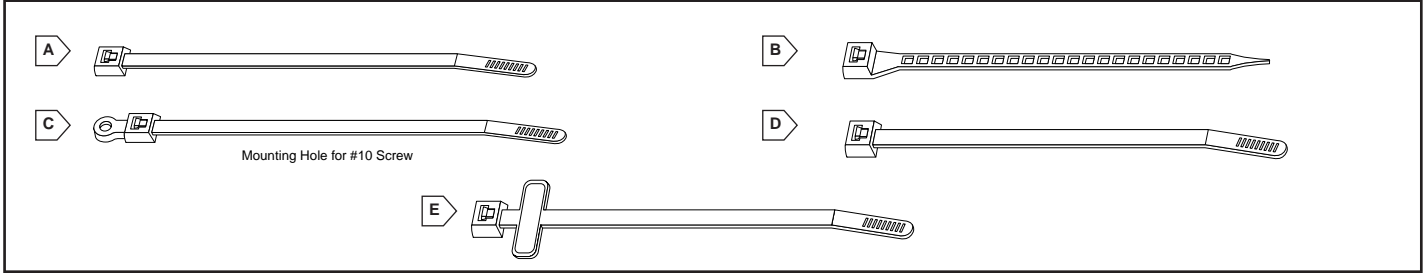

## BAR-LOK® CABLE TIES

- Features:**
- Manufactured of 100% nylon
  - Bent-tip design for ease of handling and installation
  - Maximum holding ability



File No. E57800

**Specifications:**

- Type 6/6 nylon
- Self-extinguishing - UL94 flam., class: V-2
- Meet MIL-S-23190, MS3367, ASTM D 4066-82
- Operating temperature: -40°C to 85°C
- Heat stabilized: -40°C to 105°C

### Miniature Ties

For quantities greater than listed, call for quote.

MOUSER STOCK NO.	Fig.	Style	Tensile Strength (Lbs.)	Length (In.)	Max. Bundle Dia. (In.)	Price Each		
						1	100	1000
514-08429	A	Natural	18	3.25	5/8	.05	.035	.017
514-08432	A	Natural	18	4	7/8	.05	.038	.018
514-08433	A	Black, weather resist.	18	4	7/8	.05	.032	.014

### Screw Mount-Standard Ties

For quantities greater than listed, call for quote.

MOUSER STOCK NO.	Fig.	Style	Tensile Strength (Lbs.)	Length (In.)	Max. Bundle Dia. (In.)	Price Each		
						1	100	1000
514-08484-1	C	Natural	50	7.5	1 3/4	.22	.179	.086
514-10350	C	Natural	50	11	3	.27	.210	.100

### Intermediate Ties

For quantities greater than listed, call for quote.

MOUSER STOCK NO.	Fig.	Style	Tensile Strength (Lbs.)	Length (In.)	Max. Bundle Dia. (In.)	Price Each		
						1	100	1000
514-08376	A	Natural	40	5.5	1 1/4	.07	.056	.026
514-08377	A	Natural	40	8	2 1/8	.10	.077	.037
514-08380	A	Black, weather resist.	40	8	2 1/8	.10	.077	.037
514-08680	A	Purple	40	8	2 1/8	.10	.077	.037

### Slim Line Ties

For quantities greater than listed, call for quote.

MOUSER STOCK NO.	Fig.	Style	Tensile Strength (Lbs.)	Length (In.)	Max. Bundle Dia. (In.)	Price Each		
						1	100	1000
514-10325	D	Natural	18	8	2 1/8	.06	.050	.027
514-10327	D	Black, weather resist.	18	8	2 1/8	.08	.060	.027
514-10335	D	Natural	40	15	4	.23	.170	.082

### Standard Ties

For quantities greater than listed, call for quote.

MOUSER STOCK NO.	Fig.	Style	Tensile Strength (Lbs.)	Length (In.)	Max. Bundle Dia. (In.)	Price Each		
						1	100	1000
514-08387	A	Natural	50	7.5	1 3/4	.09	.040	.032
514-08600	A	Natural	50	11	3	.22	.179	.083
514-10036	A	Natural	50	15	4	.30	.230	.116
514-10037	A	Black, weather resist.	50	15	4	.30	.230	.116

### Miniature Identification Ties

- Features:**
- Mark on textured tab with cable tie marking pen (sold separately)
  - Can be heat stamped

**Specifications:**

- Type 6/6 nylon
- Self-extinguishing - UL94 flam., class: V-2
- Designed in accordance with MIL-S-23190 and MS 3368



File No. E57800

For quantities greater than listed, call for quote.

MOUSER STOCK NO.	Fig.	Style	Tensile Strength (Lbs.)	Length (In.)	Max. Bundle Dia. (In.)	Price Each		
						1	100	1000
514-08412	E	Natural, ID	18	4	7/8	.17	.130	.062

### Ladder Ties

For quantities greater than listed, call for quote.

MOUSER STOCK NO.	Fig.	Style	Tensile Strength (Lbs.)	Length (In.)	Max. Bundle Dia. (In.)	Price Each		
						1	100	1000
514-08472	B	Black, heat stabilized	40	7	1 3/4	.07	.063	.028
514-08476-1	B	Natural	40	7	1 3/4	.10	.068	.033
514-08477-1	B	Natural	40	11	3	.10	.092	.044

## CABLE TIE ID PLATE (NYLON)

- Features:**
- For convenient tagging of wire bundles and cables

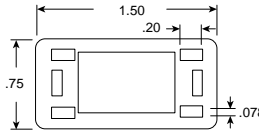

DIMENSIONS (IN.)

MOUSER STOCK NO.	Price Each			
	1	100	1000	10000
514-08457-1	.28	.147	.105	Call

## BAR-LOK® CABLE TIE MOUNTS

- Features:**
- Natural nylon (type 6/6)
  - Accommodates minimal space limitations
  - Push-in mount (fig. D) requires .25" mounting hole
  - Slips through slot easily and is securely contained for easy assembly and tensioning



MOUSER STOCK NO.	Fig.	Description	Price Each			
			1	100	500	1000
514-08462-1	A	1" adhesive 4-way mount for mini and standard ties	.50	.252	.189	
514-10045-1	B	#8 screw size, cradle mount, for standard ties	.26	.137	.100	Call
514-10046-1	B	#10 screw size, cradle mount, for heavy duty ties	.33	.168	.126	For Quote
514-10027-1	C	#8 screw size, ANC base mount, for standard ties	.20	.098	.075	
514-10028-1	C	#10 screw size, ANC base mount, for standard ties	.22	.116	.086	
514-10056-1	D	Push-in mount, for standard ties	.25	.126	.096	

## CABLE TIE INSTALLATION TOOL

- Features:**
- Adjustable, pre-set tension results in uniform cable tie application, neater bundles, more efficient harnessing
  - Slim nose construction, allows easy positioning in hard-to-reach areas or on intricate harnesses
  - Shock-resistant action for operator comfort. No "snap" when tie is cut, the tool absorbs all impact
  - Reliable, long-life construction. Extremely durable compression spring mechanism, rugged aluminum housing

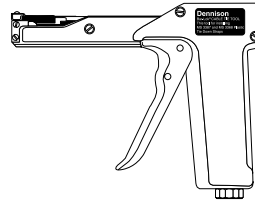

MOUSER STOCK NO.	Price Each
514-08480	109.95

## CABLE TIE MARKING PEN

- Features:**
- Smear-proof and waterproof ink for writing on all nylon surfaces

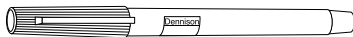

MOUSER STOCK NO.	Description	Price Each		
		1	6	12
514-08506	Cable tie marking pen, with extra-fine tip, black ink	7.68	6.40	Call

## CABLE CLIP

- Features:**
- Allows use of any width cable
  - Made of type 6 nylon
  - Accommodates stacked cable

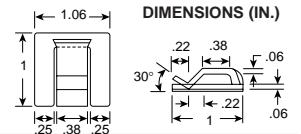

MOUSER STOCK NO.	Description	Price Each			
		1	100	500	1000
514-08406	High quality, durable, non-conductive cable clip	.58	.30	.22	Call

# AC Power Cords

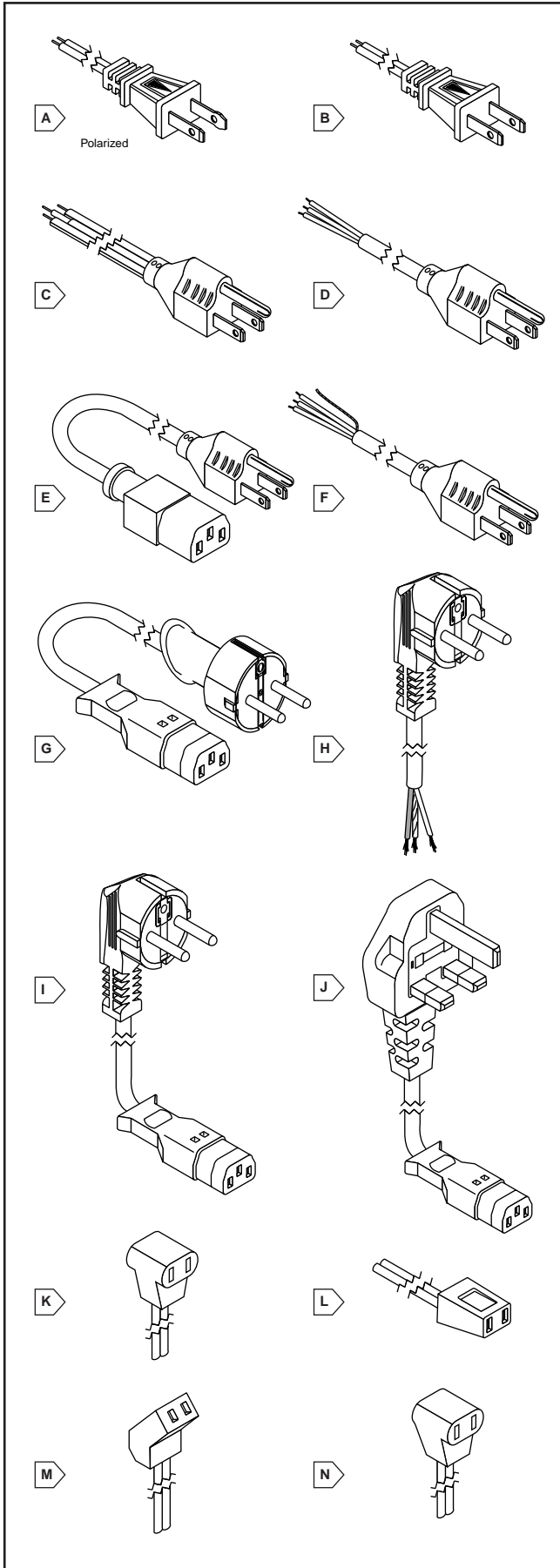

## POWER SUPPLY CORDS

Both two and three conductor types are offered in 6', 7 1/2', and 8' lengths with molded, low profile, crush resistant, NEMA 1-15P or 5-15P plugs. 18 AWG types are rated 125V, 1250 watts. 16 AWG type is rated 125V, 1625 watts. 14 AWG type is rated 125V, 1875 watts. All are UL listed and CSA certified.

### Specifications:

• Temperature:	60°C
• Rated:	AWG 18 16 14
	Volts 125 125 125
	Amps 10 13 15
	Watts 1250 1625 1875

### Features:

- Economical and efficient
- Mechanical performance meets OEM requirements
- Excellent resistance to abrasion and blade wear requirements



UL listed CSA certified

### Two Conductor Types

### NEMA 1-15P Plug

MOUSER STOCK NO.	Fig.	Replaces Belden#	Size	Type	Rating @ 125V (A)	Length	Color	Price Each			
								1	10	100	500
173-11112	A	----	18/2	SPT-1	10	6'	Black	.88	.83	.78	.74
173-11102	B	----	18/2	SPT-1	10	6'	Black	.88	.83	.78	.74
173-11123	B	----	18/2	SPT-1	10	6'	Brown	.88	.83	.78	.75
173-31102	B	----	18/2	SPT-2	10	6'	Black	1.17	1.11	1.05	.99

### Three Conductor Types

### NEMA 5-15P Plug

MOUSER STOCK NO.	Fig.	Replaces Belden#	Size	Type	Rating @ 125V (A)	Length	Color	Price Each			
								1	10	100	1,46
173-33121	C	----	18/3	SPT-2	10	6'	Gray	2.15	1.78	1.62	1.46
173-33101	C	----	18/3	SPT-2	10	6'	Black	2.15	1.78	1.62	1.46
173-53101	D	17237	18/3	SVT	10	6'	Black	2.80	2.33	2.12	1.90
173-53102	D	17239	18/3	SVT	10	8'	Black	3.37	2.80	2.54	2.29
173-53121	D	176237	18/3	SVT	10	6'	Gray	2.80	2.33	2.12	1.90
173-73101	D	17405	18/3	SJT	10	6'	Black	2.88	2.39	2.17	1.96
173-73102	D	17407	18/3	SJT	10	8'	Black	3.59	2.98	2.71	2.44
173-75102	D	----	16/3	SJT	13	8'	Black	3.39	2.82	2.56	2.30
173-78101	D	----	14/3	SJT	15	6'	Black	4.33	3.59	3.27	2.94

### Three Conductor Detachable AC Cord Set

### NEMA 5-15P Plug

MOUSER STOCK NO.	Fig.	Replaces Belden#	AWG	UL Type	Voltage Rating	Length	Color	Price Each			
								1	10	100	2,70
173-63101	E	17250	18/3	SVT	10	7'6"	Black	3.98	3.34	2.99	2.70
173-63102	E	----	18/3	SVT	10	8'	Black	4.16	3.45	3.14	2.82
173-63121	E	17250	18/3	SVT	10	7'6"	Gray	3.98	3.34	2.99	2.70

### Three Conductor Shielded Power Cords

Control the error-generating effects of ambient electrical interference.

### Features:

- Low profile molded plug
- 100% foil shield
- Drain wire terminated to ground pin of plug
- Color code: CEE
- High stranding for extended flexibility



NEMA 5-15P Plug

MOUSER STOCK NO.	Fig.	Replaces Belden#	AWG	UL Type	Voltage Rating	Length	Color	Price Each			
								1	10	100	2,51
173-53100	F	17740	18 41/34	SVT	300V	6'7"	Black	3.70	3.08	2.80	2.51

## INTERNATIONAL POWER CORDS

### Continental Europe

Conductors: 3 x 1.00(mm<sup>2</sup>)

MOUSER STOCK NO.	Fig.	Replaces Belden#	Cord Type	Rating @ 250V (A)	Length (Meters)	Color	Price Each			
							1	10	100	500
562-364002	G	17811	HO5VV-F	10	2.5	Black	5.00	4.50	4.10	3.76
562-366003	H	17811	HO5VV-F	10	2.5	Black	4.24	3.82	3.48	3.16
562-367001	I	----	HO5VV-F	10	2.5	Black	6.21	5.60	5.10	4.64

### United Kingdom

Conductors: 3 x 1.00(mm<sup>2</sup>)

MOUSER STOCK NO.	Fig.	Replaces Belden#	Cord Type	Rating @ 250V (A)	Length (Meters)	Color	Price Each			
							1	10	100	500
562-370001	J	17965	HO5VV-F	10	2.5	Black	11.30	10.23	9.30	8.22

## FAN POWER CORD

Designed for use with the Agusta 4.69" AC Tubeaxial fans. Can be used with all AC fans using .110" x .020" faston terminals with .3125" spacing. Temperature rating: 105°C (max).



E56356 LL38816

MOUSER STOCK NO.	Fig.	AWG	Cord Type	Termination	Length	Price Each			
						1	10	25	50
432-6101	K	18	SPT-1	T-type	2'	1.78	1.57	1.43	1.30



## FAN POWER CORDS

High quality fan power cords designed to be used with Tubeaxial fans. Strain relief is incorporated for added safety.

### Specifications:

- Temperature range: 105°C
- UL rated 10A / 125VAC
- CSA rated 7A / 125VAC



E118750 LR5884-5M

MOUSER STOCK NO.	Fig.	Style	Cord Type	Voltage Rating	Length	Color	Price Each			
							1	10	25	50
562-07100-24	L	Straight	SPT-1	300V	2'	Black	1.36	1.26	1.18	1.10
562-07145-24	M	45°	SPT-1	300V	2'	Black	1.36	1.26	1.18	1.10
562-07190-24	N	90°	SPT-1	300V	2'	Black	1.36	1.26	1.18	1.10
562-07199-24	K	T-Plug	SPT-1	300V	2'	Black	1.36	1.26	1.18	1.10















# Metal Working Presses and Accessories

## 3,000 LB. AND 5,000 LB. MANUPRESSES

Cuts, forms, bends, and punches: ideal for prototyping or production. Make your own panels, chassis, or cabinets.

- Maximum allowable sheet material thickness for accessories unless otherwise specified: fiberglass .079", aluminum .10", mild steel .063"
- Compact high tensile steel frame
- Pressure capability: 3,000 lbs max. (full stroke)

### 3,000 Lb. Manupress

Parameter	Dim. (In.)
Overall length	10.6
Max height (excluding-lever)	13.2
Width (w/mounting brackets)	6.5
Throat depth	5.9
Clearance	3.27
Stroke length (stop fitted)	.24 to 2.36
Ram spigot hole diameter	.71
Depth	.87
Die hole diameter	1.5
Die holder 4 holes ctr. to ctr.	2.17 x 1.38
Hole diameter	.31
Bench mtg. 4 holes ctr. to ctr.	5.9 x 3.7
Hole diameter	.39
Press weight	31.3 lbs.

(3,000 lb.)

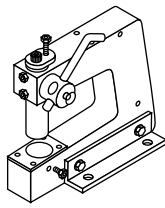

(5,000 lb.)

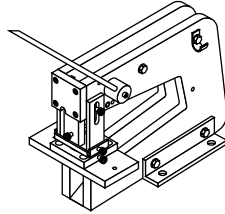

MOUSER STOCK NO.	Description	Price Each
38RA005	3000 lb. press	669.00
381-5000	5000 lb. press	1995.00
<b>Replacement Parts 3000 lb. Press Only</b>		
381-0010	Pinion rack	76.00
381-0020	Pinion gear	76.00

- Material cutting capacity (circular and rectangular punches and dies): fiberglass .079", aluminum .118", mild steel: .079"
- Double, flame-cut, steel frame
- Precision ground rack and pinion mechanism gives constant force through the stroke
- Adjustable ram controls cutting depth

### 5,000 Lb. Manupress

Parameter	Dim. (In.)
Overall length	21.7
Max height (excluding-lever)	23.6
Width (with mounting brackets)	7.8
Throat depth	12.1
Clearance	5
Stroke length	5
Ram spigot hole dia.	.98
Depth	1.2
Bench mtg. 4 holes (center to center)	8.86 x 6.61
Weight	145.5 lbs.

## INSTRUCTION BOOKLETS FOR THE 3,000 AND 5,000 LB. PRESSES

Includes all instructions, technical data and accessories.

9-125: 3,000 lb. manupress instruction sheet  
9-135: 5,000 lb. manupress instruction sheet

MOUSER STOCK NO.	Price Each
9-125	.25
9-135	.25

## ACCESSORIES FOR THE 3,000 LB. PRESS

### Slot Guillotine

Slot guillotine is used for accurate cutting and slotting without distorting the material. The cut slot is .12 x 2.76 inches.

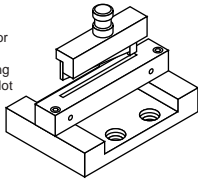

38RA515 187.83

### Corner Notching Tool

Corner notching tool is used for precise 90° angles. Adjustable stops make continuous production easy and it is particularly useful for box making.

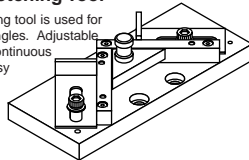

38RA015 198.43

### Side Stop

Side stop fits either side of the press for both vertical and horizontal adjustment. Maximum adjustment from ram center is 1.62" to 8.67". Maximum vertical adjustment is .79".

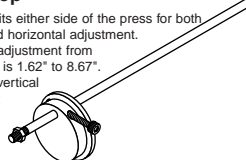

38RA700 21.73

### Circle Cutter

Enables the shear and cropping tool 38RA525 to cut circles in sheets from 2.76" (70mm) to 19.69" (500mm) radiuses.

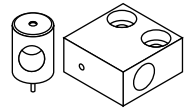

Use with 38RA525

38RA425 56.50

### "V" Bending Tool

"V" bending tool for box and panel fabrications includes five bending punches in lengths of 1.97", 2.95", 3.94", 4.92", and 5.91". The baseplate is 6.3" long and has a 90° groove to allow bends up to 90°.

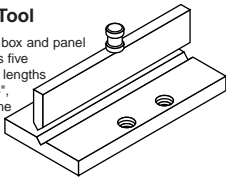

38RA115 198.99

### Shear and Cropping Lever

Shear and cropping lever with comfortable PVC handgrip gives substantial shearing action and enables .08" aluminum or .06"-.16 SWG mild steel to be cut.

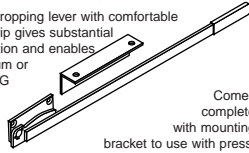

Comes complete with mounting bracket to use with press.

38RA525 126.50

### Centering Point

For making side and back stop references fit into the center hole of the press.

Can be used with both presses

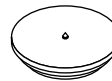

38RA800 16.40

### PCB Guide Panel Support

PCB guide panel forms looped lugs that are ideal for use as slides or for fixing panels and printed circuit boards.

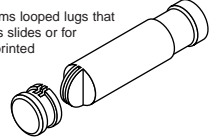

381-7004 112.79

### Louwer Tool

Louwer forming tool is used for forming ventilation apertures. Aperture size is 1.73" x .39".

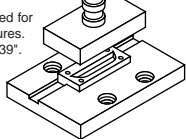

38RA215 182.99

### Nibbling Tool

This nibbling tool is used to rapidly nibble small .197" (5mm) square holes in fiberglass and S.R.B.P. boards, aluminum, and mild steel.

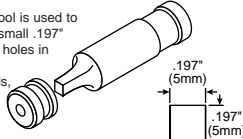

38RA035 40.49

### Back Stop

Adjustable back stop used to support sheet material. Maximum adjustment from ram center is 5.9".

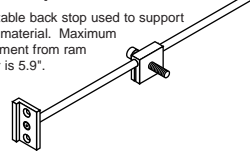

38RA300 22.20

### Domed Foot Indent Tool

Used to form "feet" on the underside of enclosures. Approximate size of foot is .157" (4mm) diameter x .118" (3mm) high depending on material thickness.

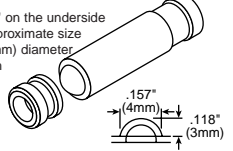

Use with Die Holder 38RA201

381-7005 62.89

## ACCESSORIES FOR THE 5,000 LB. PRESS

### Adaptor

Enables all tooling on the 3,000 lb. Mouser metal working press (38RA005) to be utilized on the 5,000 lb. manupress.

Supplied with screws and all necessary hardware.

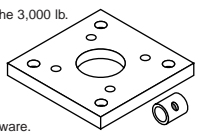

381-5001 101.43

### Cutting Tool

Ideal for slitting to accurate measurements without material distortion.

Cutting capacity: .079" fiberglass, .063" mild steel, .096" aluminum.

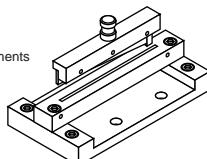

381-5003 395.00

### "V" Bending Tool

Provides bends up to 11.8" wide. Supplied with 3 blades of 7.9", 9.8", and 11.8" lengths.

Bending capacity: .063" mild steel, .098" aluminum.

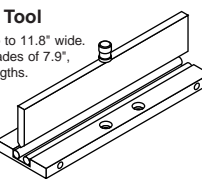

381-5005 561.23

### Side Stop

Enables material to be accurately positioned. Will adjust 0-13.8" horizontally and 0-2" vertically.

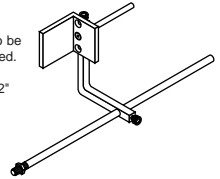

381-5007 99.48

### Die Holder

Accommodates dies for 30-50mm punches complete with locking screws plus 4 press fixing screws.

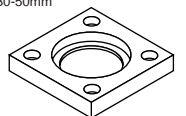

381-5002 82.65

### Louwer Tool

Ideal for producing ventilation apertures in equipment panels. Aperture size is 3.94" length x .39" width.

Cutting capacity: .063" mild steel, .098" aluminum.

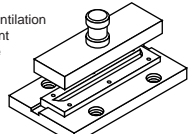

381-5004 347.98

### Corner Notching Tool

Cuts 90° notches up to 5.9" per side. Adjustable stops. Ideal for box making.

Capacity: .079" mild steel, .118" aluminum.

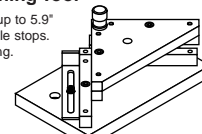

381-5006 567.98

### Back Stop

Enables the depth of work to be varied from maximum throat depth to zero.

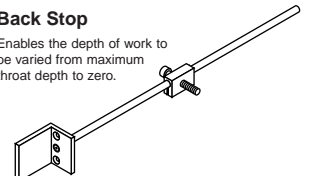

381-5008 70.89





# Panel Punches

## MOUSER® D-SUB CONNECTOR PUNCHES

The easiest way to cut holes in mild steel, aluminum, etc. is to use Mouser "D" connector hole punches. It is almost effortless when using the friction reducing ball race (which is supplied). It is a patented design, with only 6 steps from punching to mounting. 1/8" and 21/64" drills required (drills are not supplied). Punching capacity: Mild steel .065" (1.65mm), Aluminum .079" (2mm)

### Rear Mounting D-Sub Connector Punches

MOUSER STOCK NO.	No. of Pins	Dimensions (In.)		Mounting	Price Each
		Length	Width		
38DM919	9	.78	.445	Rear	247.51
38DM928	15	1.11	.445	Rear	247.51
38DM941	25	1.65	.445	Rear	247.51
38DM958	37	2.30	.445	Rear	266.79
38DM955	50	2.19	.55	Rear	266.79

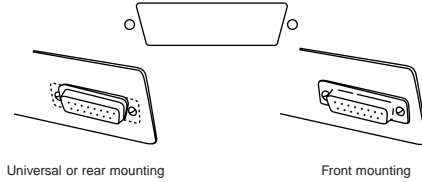

### Front Mounting D-Sub Connector Punches

• For precise installation when a universal punch just won't do

MOUSER STOCK NO.	No. of Pins	Dimensions (In.)		Mounting	Price Each
		Length	Width		
38DM921	9	.78	.51	Front	247.51
38DM929	15	1.165	.51	Front	247.51
38DM943	25	1.708	.51	Front	247.51
38DM959	37	2.354	.51	Front	266.79
38DM957	50	2.26	.618	Front	266.79

## ALL PURPOSE HAND PUNCH

For metal, plastic or masonite

Anyone can punch sharp, burr-free holes in a variety of materials to 1/16" thick untempered metals, 3/32" phenolic, 1/4" masonite. Interchangeable die set from 1/16" dia. to 1/4" dia. punches tubing as small as 3/4" dia. Powerful leverage requires little effort to operate. Shears eyelets and leaves clean undamaged holes.

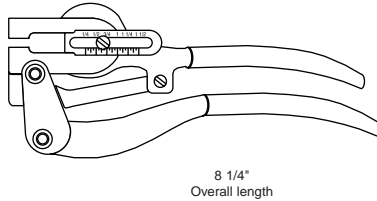

MOUSER STOCK NO.	Description	Price Each
534-1330	Hand punch	91.98
534-1331	1/16" die set	13.14
534-1332	5/64" die set	13.14
534-1333	3/32" die set	13.14
534-1334	1/8" die set	13.14
534-1335	5/32" die set	13.14
534-1336	3/16" die set	13.14
534-1337	7/32" die set	13.14
534-1338	1/4" die set	13.14
534-1339	Complete kit with hand punch and all die sets	177.39

## PANEL PUNCHES

\* Use of ball race optional other punches supplied with ball race

Punching capacity: Mild steel .065" (1.65mm), aluminum .079" (2mm)

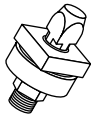

Square hole punches

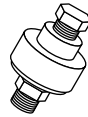

Round hole punches

### Square Metric Hole Punches

MOUSER STOCK NO.	Hole Size (mm)	Price Each
38SQ038	9.53	46.61
380-0126	12.6	51.84
* 380-0141	14.1	51.84
* 380-0168	16.8	51.84
* 38SQ034	19.1	58.69
* 380-0325	32.5	156.65
* 380-1450	45.0	345.96

### Round Metric Hole Punches

380-0125, 380-0145 & 380-0165

do not require ball races

MOUSER STOCK NO.	Hole Size (mm)	Price Each
380-0125	12.5	16.53
380-0145	14.5	19.50
380-0165	16.5	19.50
* 380-0180	18.0	19.50
* 380-0200	20.0	19.50
* 380-0225	22.5	19.50
* 380-0250	25.0	22.79
* 380-0275	27.5	22.79

### Round Metric Hole Punches

MOUSER STOCK NO.	Hole Size (mm)	Price Each
* 380-0300	30.0	22.79
380-0350	35.0	25.97
380-0400	40.0	27.33
380-0450	45.0	42.54
380-0500	50.0	51.60
380-0600	60.0	59.44
380-0700	70.0	121.36
380-0750	75.0	161.00

### Round Imperial Hole Punches

MOUSER STOCK NO.	Hole Size (In.)	Price Each
* 38RH034	3/4	19.50
* 38RH078	7/8	19.50
* 38RH100	1	22.79
* 38RH114	1-1/4	22.79
38RH112	1-1/2	31.88
38RH134	1-3/4	42.54

### Optional Ball Race

For use with square and round hole punches where ball races are optional.

MOUSER STOCK NO.	Size	Price Each
38BB002	10mm	6.44

## GREENLEE®

### ELECTRONIC CONNECTOR PANEL PUNCHES

#### Features:

- Drill only one 7/16" pilot hole
- Use wrench or hydraulic drive methods
- Capacity 22-16 gauge mild steel
- Universal size for front or back mount of connectors
- 5 piece assembly: Punch, die, draw stud, square nut, and ball bearing drive nut (in a plastic carrying case)

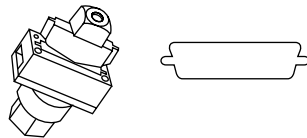

MOUSER STOCK NO.	No. of Pins	Price Each
586-0229	9	328.10
586-0231	15	328.10
586-0232	25	328.10
586-0234	37	353.63
586-0238	50	353.63

## QUICK DRAW™ HYDRAULIC PUNCH DRIVER

For 1/2"-2" conduit size use with slug-buster or standard punches

#### Features:

- 8 ton of force for punching, 10 gauge mild steel
- Adaptor converts standard Greenlee punches through 1-1/4" conduit sizes to use 7/16" draw stud for one-step punching
- Ideal for fast, straight-on front panel punching

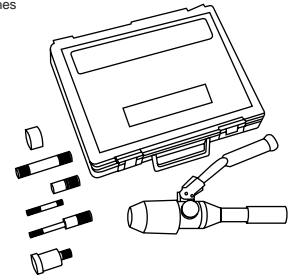

MOUSER STOCK NO.	Description	Price Each
586-7804	Driver with 3 draw studs, 2 adaptors, 1 spacer and case	470.54

## SLUGBUSTER®

### INDIVIDUAL UNITS FOR EACH CONDUIT SIZE

#### Features:

- Each unit includes punch, die and drive screw
- Capacity 10 gauge mild steel
- Use with ratchet or quick draw driver
- Also available in metric units

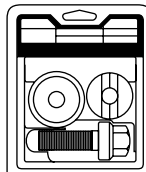

MOUSER STOCK NO.	Conduit Size (In.)	Actual Hole Dia. (In.)	Price Each	
			1	5
586-3860	1/2	.885	26.50	
586-3861	3/4	1.115	38.37	Call For Quote
586-3862	1	1.362	43.89	
586-3863	1-1/4	1.701	47.61	
586-3864	1-1/2	1.953	60.59	
586-3865	2	2.421	73.84	

## SLUGBUSTER® PUNCH SETS

#### Features:

- Multi-size punch and die sets with draw studs packaged in self-contained custom-molded carrying cases. The unique slug buster punch design splits the slug in half allowing it to fall free from the die and stud. Set 586-3868 contains the new 3/8" draw stud with 1" hex head and a new 1" ratcheting wrench.



MOUSER STOCK NO.	Description	Price Each
586-3866	6 pc. set with punches & dies for 1/2" to 1-1/4" conduit & 2 draw studs	118.70
586-3867	3 pc. set with punches & dies for 1-1/2" to 2" conduit & 1 draw stud	117.31
586-3868	9 pc. set with punches & dies for 1/2" to 2" conduit, 2 draw studs & ratcheting 1" box end wrench	236.00



# Punches, Drives, and Tools

## GREENLEE® STANDARD METAL KNOCKOUT PUNCHES

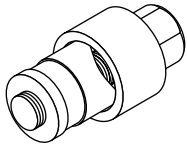

3-piece assembly: Punch, die, and draw stud

Operate manually using wrench to turn the threaded draw stud into the mating threads of the punch. This draws the punch into the die, shearing a hole in the material being punched. Can also be operated with ratchet or hydraulic punch drivers.

### Type 730 (Round)

MOUSER STOCK NO.	Hole Size (In.)	Capacity (Gauge)	Price Each		
			1	5	
586-3801	1/2	16	21.00		Call For Quote
586-3802	9/16	16	24.50		
586-3803	5/8	16	24.50		
586-3804	11/16	14	27.00		
586-3805	3/4	14	27.00		
586-3806	13/16	14	27.00		
586-3807	7/8	10	23.00		
586-3808	15/16	14	29.00		
586-3809	1	14	31.00		
586-3810	1-1/16	16	31.00		
586-3811	1-1/8	14	31.00		
586-3814	1-1/4	16	31.00		
586-3815	1-5/16	16	31.00		
586-3816	1-3/8	16	43.50		
586-3817	1-1/2	16	49.00		
586-3818	1-5/8	10	54.00		
586-3819	1-3/4	10	59.00		
586-3820	1-7/8	10	69.00		
586-3821	2	10	71.00		
586-3822	2-1/8	10	75.00		
586-3823	2-1/4	10	82.00		
586-3824	2-1/2	10	118.00		

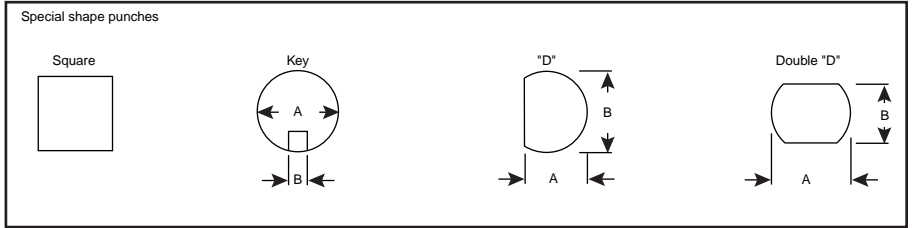

### Conduit Punches

MOUSER STOCK NO.	Conduit Size (In.)	Capacity (Gauge)	Price Each		
			1	5	
586-3880	1/2	10	23.50		Call For Quote
586-3881	3/4	10	36.50		
586-3882	1	10	41.00		
586-3883	1-1/4	10	44.00		
586-3884	1-1/2	10	55.00		
586-3885	2	10	65.50		

### Key (Formerly 732 Series)

MOUSER STOCK NO.	Size (In.) A x B	Capacity (Gauge)	Price Each		
			1	5	
586-3832	.481x.055	14	153.00		Call For Quote
586-3833	1.171x.123	14	180.00		
586-3834	1.265x.156	14	202.00		
586-3835	1.328x.102	14	249.00		

### "D" (Formerly 733 Series)

MOUSER STOCK NO.	Size (In.) A x B	Capacity (Gauge)	Price Each		
			1	5	
586-3837	.469x.5	14	137.00		Call For Quote
586-3838	.594x.625	14	146.00		
586-3839	.703x.75	14	153.00		

### Square (Formerly 731 Series)

- Use to punch holes for switches and instruments in enclosures
- Accurate alignment
  - Burr-free holes
  - Punch up to 14 gauge mild steel
  - 5-piece assembly: Punch, die, draw stud, square nut and ball bearing drive nut

MOUSER STOCK NO.	Hole Size (In.)	Capacity (Gauge)	Price Each		
			1	5	
586-3827	.5	14	137.00		Call For Quote
586-3828	.625	14	137.00		
586-3829	.75	14	144.00		
586-3830	.875	14	156.00		
586-3831	1	14	189.00		

### Double "D" (Formerly 734 Series)

MOUSER STOCK NO.	Size (In.) A x B	Capacity (Gauge)	Price Each		
			1	5	
586-3870	.769x.642	14	161.00		Call For Quote
586-3871	.795x.697	14	174.00		
586-3872	.913x.756	14	202.00		
586-3873	.913x.795	14	202.00		
586-3874	1-3/8x1-1/8	14	209.00		

## KEYSTONE WIDE ROLL EYELETS

Highest engineering standards maintained to produce these eyelets to uniform dimensions. Guaranteed to be within listed tolerances. A choice of most popular sizes in general use for electronic circuitry.

### Features:

- Material: brass
- Plating: bright electro tin
- Precision made
- Solderability retained indefinitely

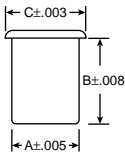
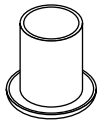

MOUSER STOCK NO.	Hole Size of Material to be Eyeleted	Dimensions (In.)				Price Each			
		A		B	C	1	100	500	1000
		I.D.	O.D.						
534-22	1/16	.045	.059	.062	.105	.05	.026	.024	.013
534-23	1/16	.045	.059	.093	.105	.06	.028	.026	.015
534-24	1/16	.045	.059	.125	.105	.06	.029	.026	.015
534-25	1/16	.045	.059	.156	.105	.07	.034	.030	.017
534-26	1/16	.045	.059	.187	.105	.07	.035	.032	.018
534-27	1/16	.045	.059	.219	.105	.08	.041	.037	.021
534-33	3/32	.070	.089	.093	.150	.06	.028	.025	.014
534-34	3/32	.070	.089	.125	.150	.06	.028	.026	.015
534-35	3/32	.070	.089	.156	.150	.06	.029	.026	.015
534-36	3/32	.070	.089	.187	.150	.06	.030	.027	.015
534-37	3/32	.070	.089	.219	.150	.06	.032	.029	.016
534-43	1/8	.102	.121	.093	.200	.06	.031	.028	.016
534-44	1/8	.102	.121	.125	.200	.06	.032	.029	.016
534-45	1/8	.102	.121	.156	.200	.07	.034	.031	.017
534-46	1/8	.102	.121	.187	.200	.07	.035	.031	.017
534-47	1/8	.102	.121	.219	.200	.07	.037	.035	.019
534-48	1/8	.102	.121	.250	.200	.07	.037	.035	.019

## SPEEDY BEND LEAD FORMERS

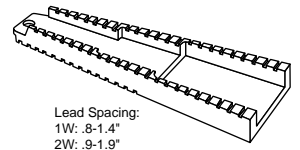
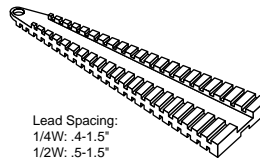

### Features:

- Watt size indicates approximate package size
- Centers components on accurate lead spacing
- Each lead former is graduated in .05" increments

MOUSER STOCK NO.	Description (Approx. Size)	Price Each	
		1	5
5166-801	1/4 watt, 1/2 watt	2.94	2.45
5166-901	1 watt, 2 watt	3.54	2.95

## KEYSTONE "BASIC" STAKING TOOL KIT

### Features:

- Build terminal boards
- Mount components quickly
- Repair circuits
- Make prototypes, at your desk

Each kit contains two 1/4" staking tools, two bottom anvils, one toolholder plus instructions. The two staking tools are for shank diameters of .062" to .098" and .110" to .125" respectively.

MOUSER STOCK NO.	Description	Price Each	
		1	5
534-1721	Staking kit	20.71	18.63

For single end terminals, eyelets or rivets

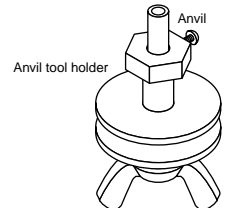

# Drills, Drill Bit Sets, and Accessories

## ISO-TIP MINI DRILL

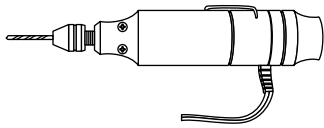

### Features:

- Variable speed 10,000 to 21,000 RPM
- Low voltage / high power
- Fan Cooled
- Lightweight / balanced design
- Permanently lubricated ball bearing
- Three-jaw universal chuck up to .140" shank
- 6 ft. cord

For quantities greater than listed, call for quote.

MOUSER STOCK NO.	Price Each		
	1	5	10
557-6636	78.95	75.00	

## ISO-TIP 15 PIECE STEEL DRILL KIT

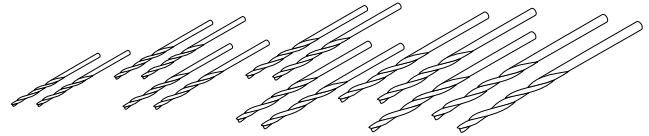

- 15 sizes .015" to .119"

MOUSER STOCK NO.	Description	Price Each			
		1	5	10	25
557-6642	15 piece steel drill kit	15.95	15.15	14.39	13.67

## ISO-TIP GRINDING STONES ASSORTMENT KIT

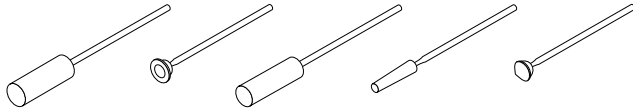

MOUSER STOCK NO.	Description	Price Each			
		1	5	10	25
557-6702	Grinding stones assortment	6.45	6.13	5.82	Call

## ISO-TIP 15 PIECE ALL PURPOSE KIT

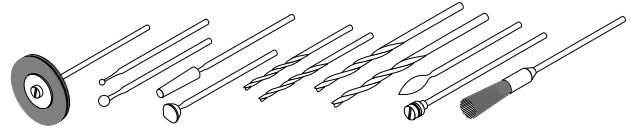

MOUSER STOCK NO.	Description	Price Each			
		1	5	10	25
557-6638	15 piece all purpose kit	22.95	21.80	20.71	19.68

## ISO-TIP FELT POLISHER ASSORTMENT KIT

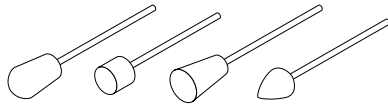

MOUSER STOCK NO.	Description	Price Each			
		1	5	10	25
557-6680	Felt polisher assortment	5.35	5.08	4.83	Call

## GENERAL PURPOSE DRILL BITS

### Features:

- Sizes for PC board applications
- High speed steel
- Straight shank
- Black finish

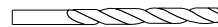

MOUSER STOCK NO.	Drill Size			Price Each				Call For Quote
	Drill No.	Hole Size (In.)	Length (In.)	1	10	20	50	
5876-409-52	52	.0635	1 7/8	.85	.77	.70	Call For Quote	
5876-409-55	55	.0520	1 7/8	.85	.77	.70		
5876-409-60	60	.0400	1 5/8	1.01	.92	.84		
5876-409-66	66	.0330	1 3/8	1.15	1.05	.95		
5876-409-69	69	.0292	1 3/8	1.35	1.23	1.12		
5876-409-75	75	.0210	1	1.55	1.41	1.28		
5876-409-80	80	.0135	3/4	1.55	1.41	1.28		

## TOOL SETS

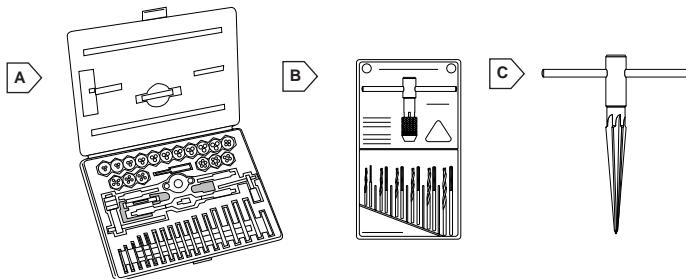

### 40 Piece Super Tap and Die Set

#4-1/2"NC and NF sizes

MOUSER STOCK NO.	Fig.	Description	Price Each
5876-44332	A	Carbon steel plug taps with 1" round screw adjusting dies for 17 most common thread sizes. Includes die stock, tap wrench, (2) T-handle tap wrenches, screw pitch gauge, screwdriver, and molded case.	126.32

### 13 Piece Threading Set

MOUSER STOCK NO.	Fig.	Description	Price Each
5876-41095	B	Packed in an attractive vinyl display pouch. Contents: 6 wire gauge 135° split point screw machine length HSS drill bits, no.'s 43, 35, 29, 25, 21, and 7; 6 plug taps, 4-40NC, 6-32NC, 8-32NC, 10-24NF, and 1/4-20NC plus tap wrench	11.68

### T-Handle Reamer

MOUSER STOCK NO.	Fig.	Description	Price Each
5876-44268	C	Hardened and ground steel reamer for removing burrs or enlarging holes in sheet, plastics and similar material. Enlarges holes 1/8" to 1/2"	8.40

## DRILL BIT SETS

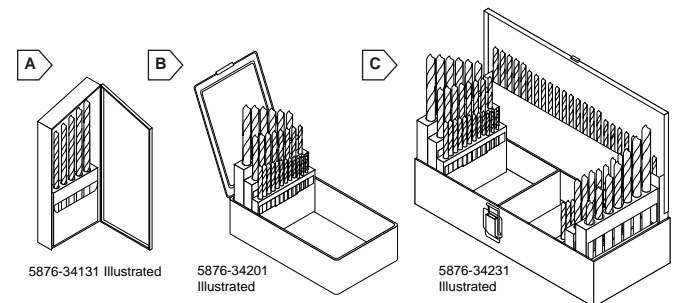

- High speed steel
- Industrial quality
- Black ferrous oxide finish cases (Except 575-34246 which is plastic)
- Straight shanks (except for 575-34156 which has 3/8" reduced shanks)

For quantities greater than listed, call for quote.

MOUSER STOCK NO.	Fig.	Description	Price Each
5876-34246	A	20 piece set: No. 61-80 (.0390" - .0135"), plastic case	18.14
5876-34131	A	13 piece set: No. 1/16" - 1/4" in 1/64" increments	11.49
5876-34156	B	15 piece set: No. 1/16" - 1/2" in 1/32" increments, 3/8" reduced shanks	35.34
5876-34181	B	21 piece set: No. 1/16" - 3/8" in 1/64" increments	30.30
5876-34201	B	29 piece set: 1/16" - 1/2" in 1/64" increments	61.49
5876-34241	B	60 piece set: No. 1-60 (.2280" - .0400")	44.69
5876-34231	C	115 piece set: 1/16" - 1/2" in 1/64" increments; letters A-Z (.2340" - .4130") No. 1-60 (.2280" - .0400")	183.92

## KNURLED NUT TOOL

Designed specifically for tightening 4mm and 6mm slotted knurled nuts. This is the perfect tool for Mouser's 2.5mm and 3.5mm phone jacks: P/N's 16PJ100/125/126/128 (2.5mm) and 16PJ011/135/136/137/138 & 164-1010 (3.5mm)

MOUSER STOCK NO.	Knurled Nut Size (mm)	Blade Length (In.)	Total Length (In.)	Price Each		
				1	5	10
382-0004	4	3	5 7/8	6.99	5.60	Call
382-0006	6	3	5 7/8	6.99	5.60	Call

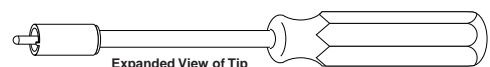

- Introduced by popular demand
- Nickel plated finish
- Accurately mates into knurled nut slots which are spaced 180° apart.

To be used on knurled nuts, on jacks, or the replacement knurled nuts, 48KN004 and 48KN006 sold on page 317.

## STANDARD BASE (300)

Standard base holds all regular 300 series heads and PCB holders. Split-ball feature permits work in various positions - turns and tilts. 3 base mounting holes in the lugs allow permanent mounting of base.



591-300 \$ 19.99

## LOW PROFILE BASE (305)

Low profile base has same features as model 300 except it is only 2 1/2" high, for working close to bench surface. Can also be permanently mounted.

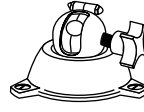

591-305 \$ 19.99

## WEIGHTED BASE MOUNT (308)

Weighted base mount holds model 300 or 305 base with 3 screws and nuts, which are included. Weighs 5 lbs., cast iron.



591-308 \$ 27.99

## BENCH CLAMP (311)

Bench clamp designed for bases 300 and 305 with screws supplied. Height 6 3/4", throat depth 2 3/8", gripping range 0"-3 1/2"



591-311 \$ 38.99

## STANDARD VISE HEAD (303)

Standard vise head has 2 1/2" wide nylon jaws that open 2 1/4" and allow firm but damage-free grip. Fits 300 and 305 bases.

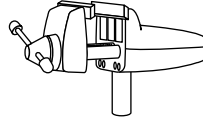

591-303 \$ 23.99

## NYLON JAWS (343 AND 344)

No. 343: Nylon jaws for 303 vise; type 66 nylon; electrical insulation withstands continuous heat of 200°F.

No. 344: Grooved nylon jaws with horizontal V-groove designed to hold small objects



No. 343  
Nylon jaws for 303-1 Vise

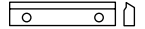

No. 344  
Grooved nylon jaws

591-343 \$ 2.49  
591-344 \$ 3.49

## CIRCUIT BOARD HOLDER (315)

Circuit board holder; holds PC boards of any shape, up to 12" wide in any position. Tension arm permits easy board insertion. Both arms extend 6" from the bar, with V-groove grip designed to hold PCB's up to 5/32" thick. Fits all 300 series bases.

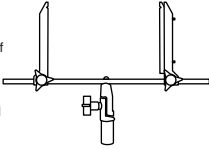

591-315 \$ 29.99

## WIDE OPENING VERTICAL VISE HEAD (366)

Wide opening vertical vise head fits all 300 series bases. Neoprene reversible, replaceable pads, rotates 360°. Tilt action 180°, grip range 0"-6", jaw pad width 1 3/4", throat depth 2".

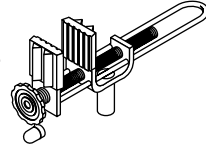

591-366 \$ 30.99

## STANDARD PANAVISE (301)

All purpose work holding unit. It tilts, turns, and rotates. This combination consists of the 300 Standard Base and the 303 Standard Head which has 2 1/2" wide nylon jaws that open 2 1/4" for firm but damage free grip. Control knob locks the work firmly in any position.



591-301 \$ 42.99

## WIDE OPENING HEAD (396)

A combination of the 366 Wide Opening Head and the 300 Standard Base, which makes this holding device very versatile for production lines, technicians, and designers. It opens to a full 6" to accommodate most PC boards. The deep-ribbed neoprene jaw pads reverse to hold delicate cylindrical objects: such as timers, coils, motor armatures, etc...

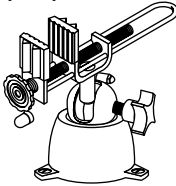

591-396 \$ 45.99

## ELECTRONIC WORK CENTER (324)

A complete electronic work center. The work station gives you a circuit board holder, standard base, tray base mount, and solder station, all in one package. Keeps work areas more efficient and manageable.

Soldering iron not included.

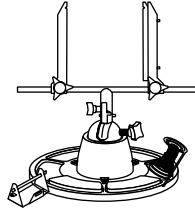

591-324 \$ 76.99

## PV JR. MINI PANAVISE (201)

More like a tool than a vise, the grooved jaws open to 2 7/8" and are made of fiber reinforced thermal composite alloy. Jaws are controlled with a fine/coarse adjusting knob which permits very delicate work.

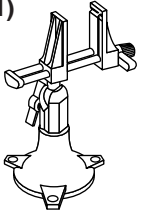

591-201 \$ 19.95

## VACUUM BASE (380-45)

A special base for portable applications. Moving the black-tipped lever arm attaches the vacuum base instantly to any smooth non-porous surface, without marring. A flip of the lever releases the base. Accepts all 5/8" stems into base. Special head can tilt 45 degrees.

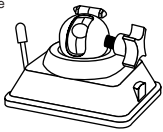

591-380-45 \$ 31.99

## TRAY BASE MOUNT (312)

Designed for the low profile, and standard base. This is a very stable work platform, yet is easily portable. Six individual trays are cast into base for holding of small parts. Tray mount is exceptionally stable and resists tipping. It has 6 non-marring, anti-skid base pads. Standard base attached with 3 screws included with base.

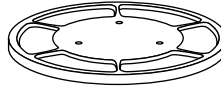

591-312 \$ 19.99

## IDC BENCH ASSEMBLY PRESS (505)

A rugged, practical installation tool designed for low volume, mass termination of various IDC connectors on flat (ribbon) cable. Interchangeable base plates accommodate a broad range of IDC connectors, and are capable of mass terminating up to 64 conductor cable in seconds without wire stripping or soldering

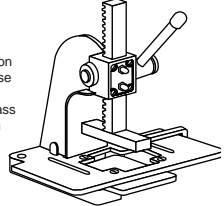

591-505 \$ 166.99

## IDC BENCH ASSEMBLY PRESS ACCESSORIES (Use with Mouser Stock No. 591-505)

DIMENSIONS (IN.)		DIMENSIONS (IN.)		DIMENSIONS (IN.)		DIMENSIONS (IN.)	

MOUSER STOCK NO.	Fig.	Description	Price Each
591-510	A	For female socket transition connectors. Fits: Ansley, Amphenol/Spectra Strip, 3M/AP Products, Alpha, Augat, Souriau	26.99
591-510A	B	For female socket transition connectors. Fits: Belden	26.99
591-511	C	For card edge connectors. Fits: Ansley, 3M/AP Products, Alpha	26.99
591-511A	D	For delta type connectors. Fits 3M/AP Products	26.99
591-512	E	For standard DIP plugs. Fits: all makes either .100" x .300" or .100" x .600" (industry standard sizes)	26.99

MOUSER STOCK NO.	Fig.	Description	Price Each
591-512A	F	For miniature DIP Plugs. Fits: all makes .100" x .100" (industry standard)	26.99
591-513	G	For D-sub connectors. Fits: Ansley, Alpha	26.99
591-513A	H	For D-sub connectors. Fits: 3M/AP Products #925140-25-R male, 3M/AP Products #925145-25-R Female, AMP RS232 male and female	26.99
591-513B	I	For D-sub connectors. Fits: H & T	26.99
591-513C	J	For D-sub connectors. Fits: Belden	26.99

# Tools

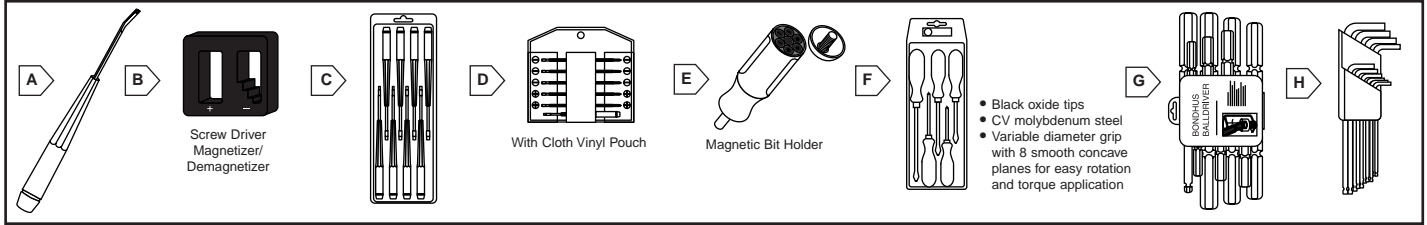

## PRECISION CHIP LIFTER- BRAND

- Features:**
- Blade: Chrome-vanadium-molybdenum-steel, hardened, chrome-plated
  - Handle: Slender, high quality plastic, impact resistant, black, cadmium free.

MOUSER STOCK NO.	Fig.	Description	Price Each	
			1	5
596-26810	A	Lifts off tight parts on printed circuit boards	7.30	6.21

## MAGNETIZER/DEMAGNETIZER- BRAND

596-40010	B	Housed in shatter proof ABS plastic	8.90	7.57
-----------	---	-------------------------------------	------	------

## PRECISION TOOL SETS- BRAND

### 8 Piece Nutdriver Sets

MOUSER STOCK NO.	Fig.	Contains	Price Each	
			1	5
596-26590	C	60mm Metric nutdrivers: 2.5mm, 3.0mm, 3.5mm, 4.0mm, 4.5mm, 5.0mm, 5.5mm, 6.0mm	59.30	50.41
596-26591	C	60mm Imperial nutdrivers: 3/32", 7/64", 1/8", 9/64", 5/32", 3/16", 7/32", 1/4"	58.90	50.07

### Hexdriver Sets

596-26390	C	7 Piece metric hexdrivers: .71 x 40mm, .89 x 40mm, 1.3 x 40mm, 1.5 x 50mm, 2.0 x 50mm, 2.5 x 60mm, 3.0 x 60mm	29.70	25.25
596-26391	C	8 Piece imperial hexdrivers: .028" x 40mm, .035" x 40mm, .050" x 40mm, 1/16" x 50mm, 5/64" x 50mm, 3/32" x 60mm, 7/64" x 60mm, 1/8" x 60mm	33.20	28.22

### Torx® Driver Set

596-26790	C	T6, T7, T8, T9, T10, and T15 with case	36.20	30.77
-----------	---	--	-------	-------

### Screwdriver Sets

MOUSER STOCK NO.	Fig.	Contains	Price Each	
			1	5
596-26090	C	Slotted: 1/16", 5/64", 3/32", 1/8", 9/64", & 5/32"	25.40	21.59
596-26190	C	Slot/phil: 1/16", 5/64", 3/32", 1/8", #00, #0 & #1	29.98	25.48
596-26990	D	Handle and 3 reversible tips: 2mm x #00, 3mm x #0, 4mm x #1	30.30	25.76
596-26991	D	Handle and 5 reversible tips: 1.5 x 3mm, 2 x 3.5mm, 2.5 x 4mm, #000 x #00, #0 x #1	49.10	41.74

## PRECISION TOOL SETS- BRAND (cont.)

### 1/4" Magnetic Bit Holder Set • Insulated blade for safety

MOUSER STOCK NO.	Fig.	Contains	Price Each	
			1	5
596-38006	E	Insulated magnetic bit holder with 1/4" drive. Bits 1", 3/16", 1/4", 5/16", #1, #2, and #3	17.80	15.13

### Mechanics' Power Handle™ Screwdriver Set

596-30892	F	Slotted, 7/32" x 4", 1/4" x 5", 3/8" x 7" Phillips, #1 x 3" and #2 x 4"	39.00	33.15
-----------	---	---	-------	-------

## TOOL SETS

### Balldriver® Hexdriver Sets • Industrial quality hardened blades

MOUSER STOCK NO.	Fig.	Contains	Price Each	
			1	5
596-10632	G	8 piece set includes: .050", 1/16", 5/64", 3/32", 7/64", 1/8", 9/64", 5/32"	16.15	13.73
596-10637	G	13 piece set includes: .050", 1/16", 5/64", 3/32", 7/64", 1/8", 9/64", 5/32", 3/16", 7/32", 1/4", 5/16", 3/8"	41.13	34.96
596-10687	G	7 piece set includes: 1.5mm, 2mm, 2.5mm, 3mm, 4mm, 5mm, 6mm	15.53	13.20
596-10699	G	9 piece set includes: 1.5mm, 2mm, 2.5mm, 3mm, 4mm, 5mm, 6mm, 8mm, 10mm	33.05	28.09

### Balldriver® L-Wrench Sets • Industrial quality hardened blades

MOUSER STOCK NO.	Fig.	Contains	Price Each	
			1	5
596-10932	H	8 piece set includes: .050", 1/16", 5/64", 3/32", 7/64", 1/8", 9/64", 5/32"	7.99	6.79
596-10938	H	10 piece set includes: 1/16", 5/64", 3/32", 7/64", 1/8", 9/64", 5/32", 3/16", 7/32", 1/4"	10.95	9.31
596-10936	H	12 piece set includes: .050", 1/16", 5/64", 3/32", 7/64", 1/8", 9/64", 5/32", 3/16", 7/32", 1/4", 5/16", 3/8"	13.90	11.82
596-10937	H	13 piece set includes: .050", 1/16", 5/64", 3/32", 7/64", 1/8", 9/64", 5/32", 3/16", 7/32", 1/4", 5/16", 3/8"	17.72	15.06
596-10946	H	6 piece set includes: 1.5mm, 2mm, 2.5mm, 3mm, 4mm, 5mm	5.99	5.09
596-10999	H	9 piece set includes: 1.5mm, 2mm, 2.5mm, 3mm, 4mm, 5mm, 6mm, 8mm, 10mm	14.74	12.53

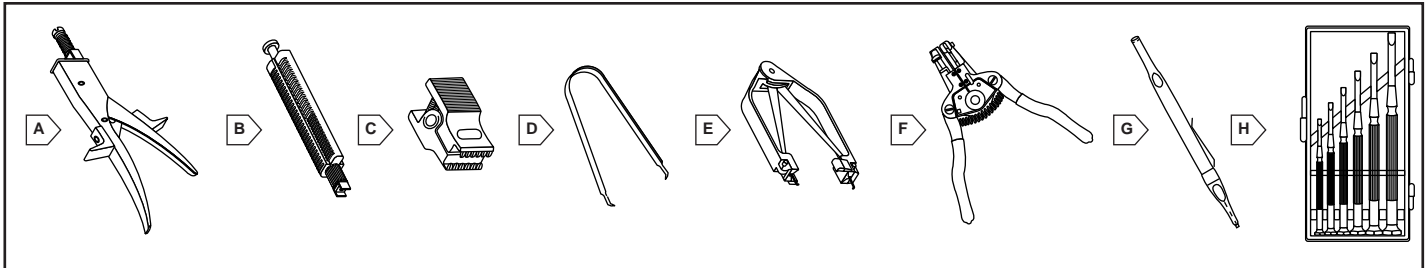

## DELUXE NIBBLING TOOL

MOUSER STOCK NO.	Fig.	Description	Price Each
524-806	A	Nibbler with spring operated stripper	15.46

## ANTI-STATIC IC INSERTION TOOLS

524-12-4108	B	8 pin insertion tool	10.45
524-12-4116	B	14 - 16 pin insertion tool	10.45
524-12-4120	B	18 - 20 pin insertion tool	10.38
524-12-4122	B	22 pin insertion tool	13.32
524-12-4128	B	24 - 28 pin insertion tool	13.32
524-12-4140	B	36 - 40 pin insertion tool	13.32

## IC EXTRACTOR TOOLS

381C565	C	Spring action clip extractor for use up to 16 pin	3.41
524-9227	D	IC spring steel extractor	3.22

## PLASTIC LEADED CHIP CARRIER (PLCC) REMOVAL TOOL

MOUSER STOCK NO.	Fig.	Description	Price Each
381-1000	E	PLCC removal tool, anti-static	13.50

## STANDARD WIRE STRIPPERS

524-766	F	12 - 20 AWG stripper	18.04
524-766-A	F	14 - 30 AWG stripper	19.25

## TRIMMER POTENTIOMETER ADJUSTMENT TOOL

594-8T000	G	Glass filled nylon body, stainless steel blades	1.00
-----------	---	---	------

## PRECISION SCREWDRIVER SET

38TS100	H	6 piece slotted set with clear-view plastic case	12.91
---------	---	--	-------

• Sizes (mm): .8, 1.4, 2.0, 2.4, 2.9, 3.8

# Tools

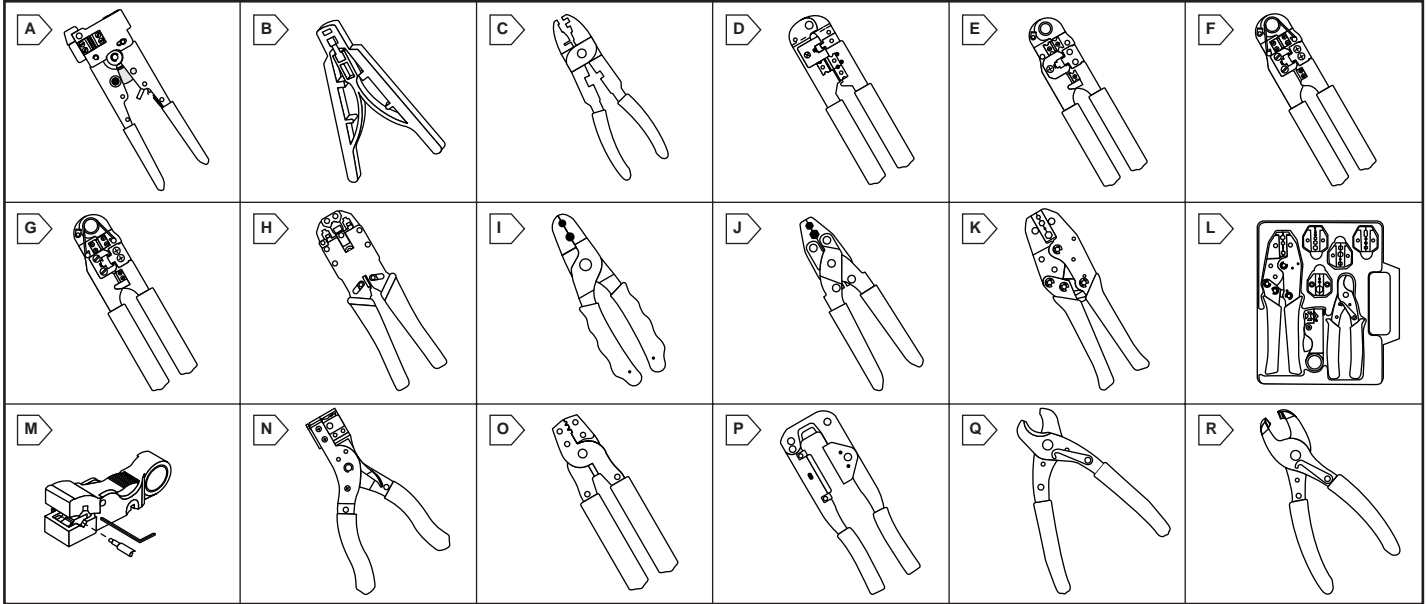

## AMP MODULAR CRIMPING TOOLS

### "Category 5" High Performance Crimp Tool

- Cuts, strips, and terminates cable
- All plug sizes, except 10-position, are accommodated using interchangeable die sets

MOUSER STOCK NO.	Fig.	Description	Price Each
571-32316520	A	8-position modular crimp tool with die	108.95

### Economy Hand Tool

- Strips and terminates cable
- Light weight

571-2316481	B	For 2, 4, and 6-position plugs	24.95
571-2316491	B	For 4-position handset plugs	24.95

### Super Champ Hand Tool

- Separate nests for terminating wires and engaging the insulation strain relief

571-1897101	C	2, 4, 6, & 8-position line; long and keyed modular plugs	29.95
-------------	---	--	-------

### Professional Hand Tools with Die Set

- Cuts, strips, and terminates cable
- All plug sizes, except 10-position, are accommodated using interchangeable die sets

571-22316521	A	For 8-position line	108.95
571-22316523	A	For 4-position handset	108.95
571-22316526	A	For 6-position offset-latch	108.95
571-22316527	A	For 6-position long body	108.95
571-22316528	A	For 4, 6-position line	108.95

### Die Set Only for Professional Hand Tool

MOUSER STOCK NO.	Description	Price Each
571-8534001	8-position line	36.00
571-8534003	4-position handset	36.00
571-8534006	6-position offset-latch	36.00
571-8534007	6-position long body	36.00
571-8534008	4,6-position line	36.00

### Professional Hand Tool Kits

MOUSER STOCK NO.	Description	Price Each
571-12316660	4, 6, 8-position die sets, set of replacement strip blades and small screwdriver	168.95
571-12316661	4-position handset, 4, 6, and 8-position die sets, set of replacement strip blades and small screwdriver	201.50
571-2316625	(1) set of strip blades	4.95

## MODULAR CRIMPING TOOLS

### Economy 3-Way Modular Crimping Tools

- Cuts, strips, and crimps
- Hardened steel frame
- Black oxide finish
- Lightweight and durable

MOUSER STOCK NO.	Fig.	Description	Price Each
382-2194	D	For 4P4C and 4P2C plugs	16.43
382-2196	D	For 6P6C, 6P4C, & 6P2C plugs	16.43
382-2198	D	For 8P8C modular plugs	17.89

### 3-Way Modular Crimping Tools

- Deluxe types with Safe Guide and closed lock for storage
- Cuts, strips, and crimps
- Hardened steel frame
- Black oxide finish
- Lightweight and durable

MOUSER STOCK NO.	Fig.	Description	Price Each
382-2094C	E	For 4P4C and 4P2C plugs	17.76
382-2096C	E	For 6P6C, 6P4C, & 6P2C plugs	19.38
382-210C	F	For 8P8C modular plugs	21.48
382-2092C	G	For 10P10C modular plugs	34.10

### Replacement Blades

MOUSER STOCK NO.	Fits	Price Each
382-20961	382-2194, 382-2196, 382-2198, 382-2094C, and 382-2096C	3.72

### Professional Modular Crimping Tool

8" professional modular crimping tool cuts, strips, and crimps the more popular modular plugs. This tool is designed for crimping 8P8C, 6P6C, 6P4C, 6P2C, 4P4C, and 4P2C modular plugs with stranded flat wire.

MOUSER STOCK NO.	Fig.	Description	Price Each
382-2008	H	For 4, 6, and 8-position plugs	99.95

## "F" CRIMPING TOOLS

### Economy "F" Crimping Tools

MOUSER STOCK NO.	Fig.	Description	Price Each
382-0058	I	For RG-58/U	3.44
382-0059	I	For RG-59/U	3.29

### Parallel Action "F" Crimping Tool

MOUSER STOCK NO.	Fig.	Description	Price Each
382-0242	J	9" deluxe hex type for RG59 and aluminax RG6	8.55

## COAX CRIMPING TOOL

- Crimps: RG6, 59, 62, 140, 210, Belden 8279, 55, 58, 141, 142, 223, 303, 400, fiber optic

MOUSER STOCK NO.	Fig.	Description	Price Each
382-301C	K	Ratchet hex tool for F, FNC, TNC, N, Teflon, Thinnet-PVC, and Fiber Optic connectors	36.89
382-0330	L	Coax tool kit, includes: (1 ea.) 382-301C Heavy Duty Professional Hex Crimp Tool, assortment of dies to work with the following types of coaxial cable: RG6, 8, 8X, 9, 11, 55, 58, 59, 62, 87A, 122, 140, 141, 142, 149, 165, 174, 178, 179, 180, 187, 188, 195, 210, 213, 214, 216, 223, 225, 303, 316, 400, Fiber Optic, Belden types 8218, 8279, and 9913, Coax stripper that works with RG58, 59, 62, 6, and 3C2V cable, Heavy duty 6-1/2" cable cutter that works with .16" to .413" cable	89.95

## ROTARY CABLE STRIPPERS

- 3 blade models
- No replacement cassettes needed
- Comes with allen wrench adjustment tool

382-312A	M	Preset for stripping RG59/62/6	21.76
382-312B	M	Preset for stripping RG58/59/62	21.76

## CABLE TIE TOOL

- Accepts cable ties up to .07" thick
- Steel

382-2081	N	6-1/2" long, black oxide finish	12.40
----------	---	---------------------------------	-------

## D-SUB CRIMP TOOL

382-0213	O	For computer pins and sockets D-sub 20-28 AWG wire	18.48
----------	---	--	-------

## IDC CRIMPING PLIERS

- Easy to assemble flat cable onto IDC type connectors
- Crimping distance for connectors height from .236" to 1.06"

382-0214	P	9-1/2" long, steel frame	18.15
----------	---	--------------------------	-------

## CABLE CUTTER

- Hardened carbon steel
- Curved blade cuts wire .016" to .413"

382-0206	Q	6-1/2" long, black oxide finish	8.37
----------	---	---------------------------------	------

## STRAIN RELIEF AND FITTING PLIER

- Bushing capacity up to 3/4" diameter
- For STP-1 and STP-2 wire

382-0205	R	6.8" long, steel material, and black oxide finish	10.23
----------	---	---	-------



# Electronic Pliers

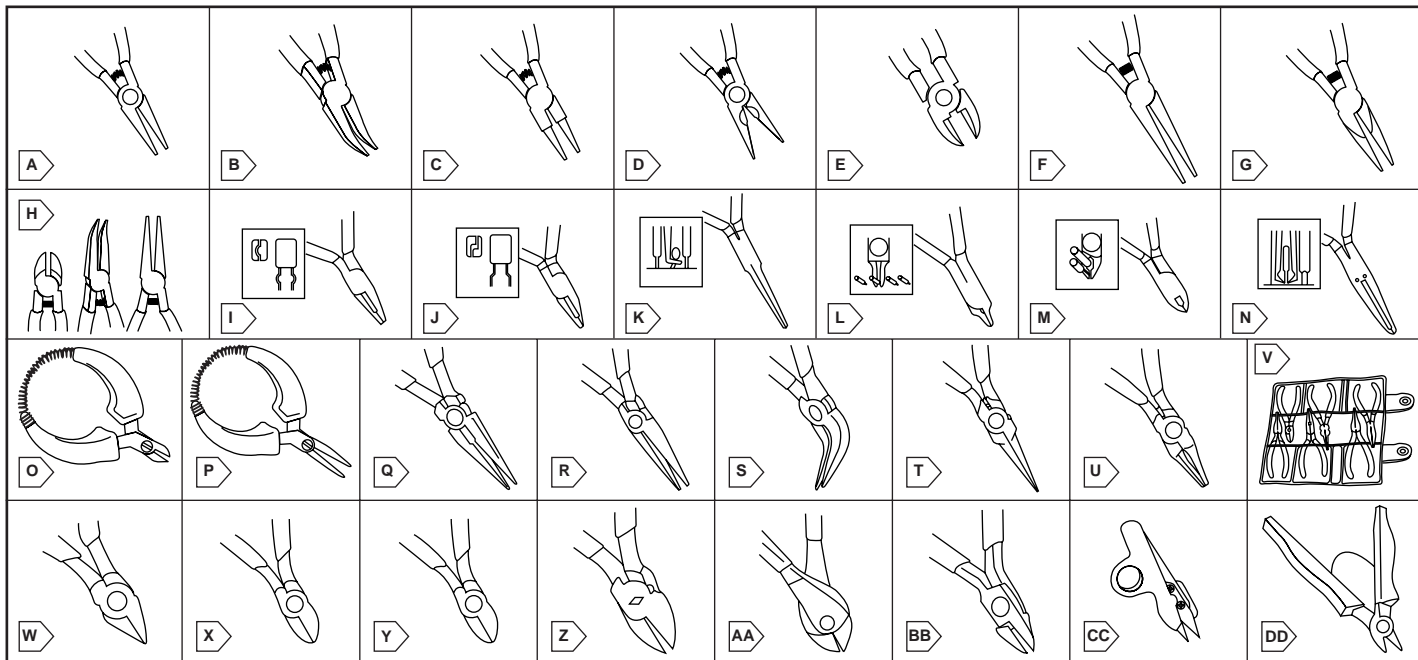

## MINIATURE PLIERS

Ideal for precise PCB work. Recommended for cutting copper and soft lead wires. Return spring, durable box joint and smooth insulated grips. Long nose pliers have serrated tips with smooth inside jaw.

MOUSER STOCK NO.	Fig.	Description	Price Each
382-0152	A	4" flat nose pliers	5.81
382-0153	B	4" bent nose plier, 45° slant	5.81
382-0154	C	4" straight nose internal pliers	5.81
382-0155	D	4" long nose with side cutter and serrated tip	5.50
382-0300	E	4 1/2" side cutter, flush cut	5.45
382-0302	F	5" flat nose plier with smooth jaws	5.45
382-0305	G	4 1/2" long nose without cutter, serrated tip	5.45
382-0704	H	3 pc. plier set incl. 5" long nose, 4 1/2" side cutter, 5" bent nose	15.74

## PC BOARD "DREAM" TOOLS

Small, lightweight pliers. Designed primarily for holding, bending, and cutting fine wires in electronic, radio, TV, and electrical work. • Take a look at what these pliers can do

MOUSER STOCK NO.	Fig.	Size (In.)	Description	Price Each
383-1001	I	4 1/2	Lead Forming, forms strain reliefs in component leads and indents in leads to hold components during wave soldering.	24.09
383-1002	J	4 1/2	Lead Bending, for adjusting lead spacing on small components.	24.09
383-1003	K	5 1/2	Bent Nose, manipulates and dresses components in tight spaces.	23.71
383-1004	L	5	Nippers, very narrow cutting head for cutting in close spaces.	25.41
383-1005	M	5	Tip Cutters, cutting tool for those crowded, inconvenient areas.	25.41
383-1006	N	5 1/4	End Cutting Nippers, "Top down" cutting for high density areas.	27.10

## PALM GRIP SERIES

- Precision, rust proof stainless steel
- Good for: PC boards, setting precise and small parts, assembling plastic hobby models, cutting small wires, fishing, and hundreds of other tasks
- Spring loaded with minimal travel

MOUSER STOCK NO.	Fig.	Color	Description	Price Each
382-1017	O	Red	Flush cutter	14.87
382-1018	P	Blue	Flat nose pliers (serrated)	14.87
382-1019	--	Tan	Flat nose pliers	14.87
382-1020	--	Yellow	Round nose pliers	14.87
382-1021	--	Green	Needle nose pliers	14.87
382-1022	--	Orange	Curved nose pliers	14.87

## Diamond/Xcelite® PLIERS

Models with an asterisk (\*) have unique corrosion proof Copaloy® copper alloy rivet joints. They act like precision bearings to eliminate steel-on-steel friction and maintain perfect alignment of tips and cutting edges. All Copaloy® pliers come with coil springs. All models below have green plastic handles. For quantities greater than listed, call for quote.

MOUSER STOCK NO.	Fig.	Size (In.)	Description	Price Each
* 578-SN54	Q	4 7/8	Long nose with side cutter, finely scored jaws	14.53
* 578-SN55	Q	5 13/16	Long nose with side cutter, finely scored jaws	14.52
* 578-L4	R	4	Long nose subminiature, very fine point	11.78
* 578-LN56P	R	6 3/4	Long nose diamond scored jaws for extra grip. For radio and telephone workers	10.89
* 578-LN54	R	4 7/8	Long nose finely scored jaws	12.93
* 578-LN55	R	6	Long nose finely scored jaws	13.29
* 578-CN54	S	4 9/16	Long curved nose (Approx 60°), smooth jaws	14.54
* 578-NN54	T	4 7/8	Needle nose finely scored jaws	15.24
* 578-NN54-1	T	4 7/8	Needle nose smooth jaws, slightly rounded edges	15.32
* 578-RN54	U	4 9/16	Round nose smooth jaws, for forming loops in wire	13.89
* 578-C1	V	- - -	Includes MS54, SN54, LN54, NN54, plus 4" traverse end cutter, 4" flat nose pliers & leather pouch w/ brass snaps	91.77
* 578-MS54-5	W	4 1/8	Flush cutting straight cutter, 7/16" cutting blade	12.59
* 578-MS54-7	X	4 1/8	Flush cutter, 7/16" cutting blade	13.32
* 578-MS54	Y	4 1/8	Diagonal cutting general purpose, 7/16" cutting blade	11.82
* 578-S54P	Z	4 1/2	Diagonal cutting general purpose, 5/8" cutting blade	13.13
* 578-S55P	Z	5 1/16	Diagonal cutting general purpose, 3/4" cutting blade	12.78
* 578-S557P	AA	7 1/8	Diagonal cutting heavy duty 25/32" cutting blade	12.63
* 578-MS54-3	BB	4 1/8	Diagonal cutting thin flush cutter, ground down on back side	13.44

## COOPER SPEED CUTTER

Cooper Tools

For quantities greater than listed, call for quote.

MOUSER STOCK NO.	Fig.	Size (In.)	Description	Price Each
578-1570B	CC	- - -	Versatile, 4-3/4" light-weight cutter with stainless steel replaceable blades. Heavy duty contoured frame	6.76

## GO CLIP AND GRIP FLUSH CUTTER

GO ELECTRONICS

For quantities greater than listed, call for quote.

MOUSER STOCK NO.	Fig.	Size (In.)	Description	Price Each
524-12-504	DD	- - -	Forged alloy steel cutters for wire up to .047" dia. (18 AWG). Retainer holds clipped ends	20.93

## Crescent® TOOLZALL™ MULTI-PURPOSE TOOL

### Features:

- Consists of 12 of the most popular tools available
- Built from stainless steel for longer life
- Ideal for the professional and handyman
- Adjustable/replaceable tool components
- Limited lifetime warranty
- Built in USA by Crescent®



ToolZall™ Pro

MOUSER STOCK NO.	Description	Price Each	
		1	6
578-TZ2V	Needle nose/regular pliers, 2 flathead screwdrivers, phillips screwdriver, metric/english ruler, wood/metal file, 2 knife blades, can/bottle opener, wire cutter, lanyard ring	53.76	50.40



# Soldering Tools

## Weller PORTASOL® CORDLESS SOLDERING TOOLS

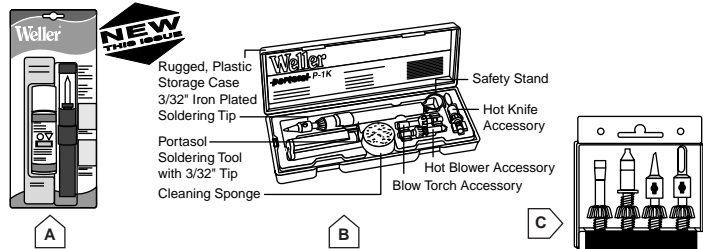

### Portasol Soldering Iron Kits

MOUSER STOCK NO.	Fig.	Kit Includes:	Price Each	
			1	4
578-C1CFB 578-P1KB	A B	Portasol iron, chisel tip, and butane cylinder 1 each: Portasol iron, 3/32" iron plated solder tip, cleaning sponge, blow torch, hot blower and hot knife accessory. Stored in a rugged plastic case.	20.94 51.63	20.24 49.90

### Portasol Butane Refills

578-WB2	--	Refill cartridges for Portasol cordless soldering iron	2.12	2.04
---------	----	--	------	------

### Portasol Tip Accessory Kit

578-TB10	C	T1, T5, T6, and T7 in a durable case	1	5
			33.83	32.70

## Weller PORTASOL TIPS

- T-1 to T-4 tips temperature range up to 850°F (450°C)
- T-5 blow torch temperature range up to 2372°F (1300°C)
- T-6 hot blower and T-7 hot knife temperature range up to 850°F (450°C)

For quantities greater than listed, call for quote.

MOUSER STOCK NO.	Fig.	Description	Price Each	
			1	5
578-T1	A	1/32" tip	8.70	8.41
578-T2	B	3/32" tip	8.70	8.41
578-T3	C	1/8" tip	8.70	8.41
578-T4	D	3/16" tip	8.70	8.41
578-T5	E	Blow torch tip	8.70	8.41
578-T6	F	Hot blower tip	8.70	8.41
578-T7	G	Hot knife tip	8.70	8.41

Soldering tips and heat tool accessories converts iron into 4 different tools: solder iron, blow torch, hot blower and hot knife.

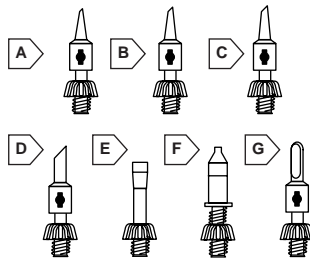

## Weller SOLDERING GUNS

- 120V 60Hz AC only
- 2-wire cord

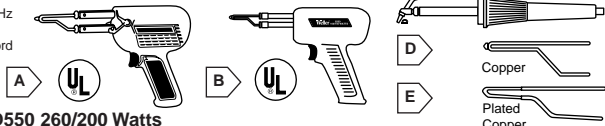

### Model D550 260/200 Watts

- High output
- Pistol-grip design
- Twin lights illuminate work
- Heavy gauge, high-efficiency copper tip

MOUSER STOCK NO.	Fig.	Description	Price Each	
			1	6
578-D550	A	Trigger selection of heats	44.16	42.69

### Model 8200 100/140 Watts

- High efficiency soldering tip of pure pre-tinned copper
- Pistol-grip design
- "Soldering Tips" booklet included

578-8200	B	Finger tip selection of high or low output	32.51	31.42
----------	---	--	-------	-------

### DS40 Desoldering / Repair Tool

- Valuable repair tool for servicing printed circuit boards and solid state electronics
- Allows components to be removed and replaced quickly with less chance of heat damage
- Complete unit includes 50w tool, vacuum bulb, desoldering assembly with DST4 tiptlet

578-DS40	C	Desoldering / repair tool	73.56	Call
----------	---	---------------------------	-------	------

### Replacement Tips

For quantities greater than listed, call for quote.

MOUSER STOCK NO.	Fig.	For Model #	Package Contains	Price Each		
				1	6	12
578-7250	D	D550	2 tips	3.77	3.64	3.34
578-8125	E	8200	2 tips	3.77	3.64	3.34

### Replacement Housing Sets

MOUSER STOCK NO.	Description	Price Each
578-8200RH	For 578-8200 soldering gun	9.51

### Replacement Tips for Soldering Guns

- Tin plated tips, made of copper

MOUSER STOCK NO.	Fig.	Description	Price Each		
			1	6	12
578-7135	D	Tip only-2 per card for 8200/9200K	3.77	3.64	3.34

## ISO-TIP™ TEMPERATURE ADJUSTABLE SOLDERING STATION

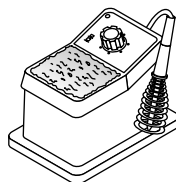

A perfect production tool for micro circuits and fine manufacturing with a pencil thin, molded nylon handle for improved accuracy and less operator fatigue.

- Compact, temperature adjustable 500° to 700°F
- Solid nickel, gold end
- Grounded tip to protect sensitive components
- Pencil thin handle for improved accuracy

MOUSER STOCK NO.	Price Each
557-7475	89.95

## ISO-TIP™ SOLDERING TIPS FOR MICRO SOLDERING STATION

With these replacement tips, you can meet most production needs in miniature soldering applications. Simply pull the old (cooled) tip off and slide a new one on. Contact a customer service representative for additional tips.

- Nickel plated copper
- Solid nickel, gold end
- Easy installation
- Use with 557-7475

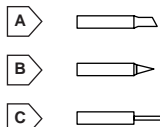

For quantities greater than listed, call for quote.

MOUSER STOCK NO.	Fig.	Type	Size (In.)	Price Each	
				1	5
557-7253	A	Spade	3/32	4.90	4.65
557-7256	B	Cone	1/25	4.90	4.65
557-7258	C	Spade	1/25	4.90	4.65

## ISO-TIP™ 7904 "POWER PRO" CORDLESS SOLDERING IRON

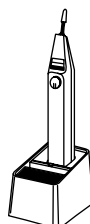

High capacity cordless soldering iron using high efficiency tips, provides up to 30 minutes of continuous soldering time from a fully charged iron or intermittently over 200 solder joints.

- Complete recharge in 4 hours
- LED in recharge stand to indicate charging status
- Tip performance up to 900°F
- Easily replaceable battery and worklight

For quantities greater than listed, call for quote.

MOUSER STOCK NO.	Price Each	
	1	5
557-7904	54.95	52.20

## ISO-TIP™ 7700 CORDLESS SOLDERING IRON



Recharges completely in 3 to 4 1/2 hours. A partially discharged battery returns to full capacity in 1 to 2 hours. Nickel cadmium battery withstands high-rate charging with out damage. Fully charged unit can make up to 125 electronic joints per charge. Cordless soldering iron, recharging stand with wall plug transformer, #7545 tip, #7546 tip, and instructions

For quantities greater than listed, call for quote.

MOUSER STOCK NO.	Price Each	
	1	5
557-7700	39.95	37.95

## ISO-TIP™ 7800 ISO TIP "60" CORDLESS SOLDERING IRON

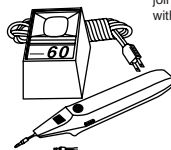

Fastest charging cordless soldering iron on the market. Solders up to 125 electronic joints per charge. Recharges fully in 1 hour. Cordless soldering iron, recharging stand with wall plug transformer, #7577 tip, #7545 tip, and instructions.

For quantities greater than listed, call for quote.

MOUSER STOCK NO.	Price Each	
	1	5
557-7800	54.95	52.20

## ISO-TIP™ WAHL HI-EFFICIENCY ISO-TIP SOLDERING TIPS

- All ISO-TIP replacement tips fit all ISO-TIP cordless irons
- Isolated tip, ground free, low voltage design eliminates electrical leaks and damage
- Intermittently 200 plus joints per charge
- Unique snap-in design
- Requires less power to heat tip

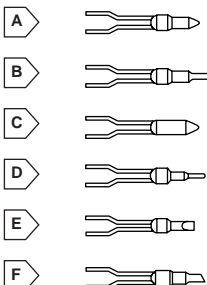

For quantities greater than listed, call for quote.

MOUSER STOCK NO.	Fig.	Description	Price Each	
			1	5
557-7535-100	A	Regular tip	4.25	4.04
557-7545-100	B	Fine tip	4.25	4.04
557-7546-100	C	Heavyduty tip	4.25	4.04
557-7566-100	D	Micro tip	4.25	4.04
557-7577-100	E	Chisel tip	4.25	4.04
557-7579-100	F	Beveled tip	4.25	4.04









# 3M Static Control Products

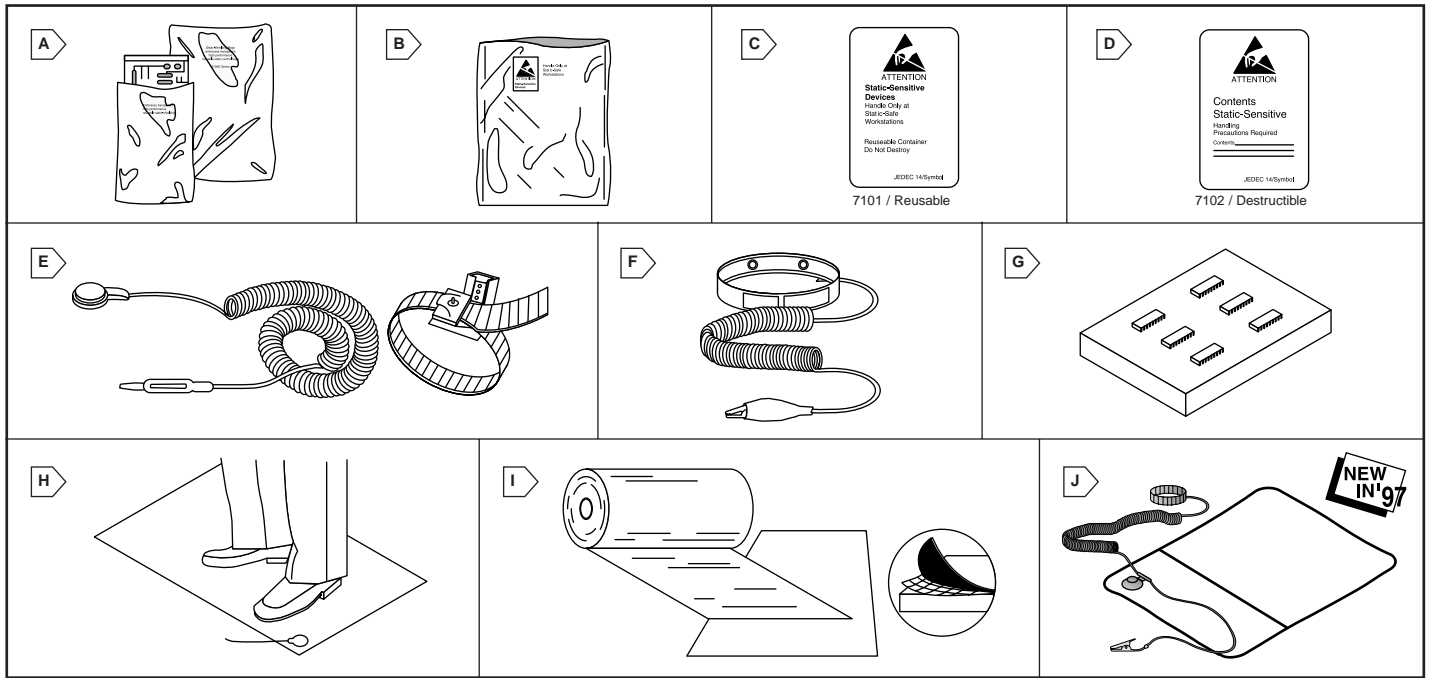

## STATIC-SHIELDING BAGS

### 2100E Series

Embosses transparent high performance reusable static-shielding bags.

MOUSER STOCK NO.	Fig.	Description	Polyester Layer Thickness	Price Per Pkg.	
				1	5
517-2100E-35	A	3" x 5" pkg./100	0.92 mil.	19.44	18.23
517-2100E-46	A	4" x 6" pkg./100	0.92 mil.	25.28	23.70
517-2100E-68	A	6" x 8" pkg./100	0.92 mil.	43.20	40.50
517-2100E-1012	A	10" x 12" pkg./100	0.92 mil.	71.70	67.22
517-2100E-1014	A	10" x 14" pkg./100	0.92 mil.	88.80	83.25
517-2100E-1115	A	11" x 15" pkg./100	0.92 mil.	105.36	98.78
517-2100E-1218	A	12" x 18" pkg./100	0.92 mil.	127.76	119.78

### 1900 Series

A more economical static-shielding bag for less demanding applications.

MOUSER STOCK NO.	Fig.	Description	Polyester Layer Thickness	Price Per Pkg.	
				1	5
517-1900-35	B	3" x 5" pkg./100	0.48 mil.	8.32	7.80
517-1900-46	B	4" x 6" pkg./100	0.48 mil.	9.60	9.00
517-1900-68	B	6" x 8" pkg./100	0.48 mil.	14.56	13.65
517-1900-1012	B	10" x 12" pkg./100	0.48 mil.	28.00	26.25
517-1900-1014	B	10" x 14" pkg./100	0.48 mil.	30.72	28.80
517-1900-1115	B	11" x 15" pkg./100	0.48 mil.	35.20	33.00
517-1900-1218	B	12" x 18" pkg./100	0.48 mil.	45.12	42.30

## ANTI-STATIC LABELS

Designed to alert personnel handling bags, boxes or other carriers that the contents are static-sensitive. Available in single use or reusable forms using the accepted industry static symbols: JEDEC-14

Size: 1 7/8" x 2 1/2"

MOUSER STOCK NO.	Fig.	Description	Labels Per Roll	Price Per Roll	
				1	5
517-7101	C	Reusable orange with black type (JEDEC-14 symbol)	500	15.62	14.57
517-7102	D	Destructible yellow with black type (JEDEC-14 symbol)	500	15.62	14.57

## ADJUSTABLE WRIST STRAP WITH GROUNDING CORD

The wrist strap consists of a wrist band and a grounding cord. The molded cap on the grounding cord that snaps onto the wrist band contains a 1 megaohm resistor.



MOUSER STOCK NO.	Fig.	Description	Price Each	
			1	5
517-2214	E	Adjustable band, 5' coiled cord	26.99	25.19
517-2204	E	Adjustable band only	11.12	10.37

## MOUSER® WRIST STRAP

• One size fits all • 1MΩ to ground

MOUSER STOCK NO.	Fig.	Description	Price Each		
			1	25	100
382-1500	F	Strap with 6ft. coiled cord and alligator clip	17.83	16.21	Call

## VELOSTAT™ ELECTRICALLY CONDUCTIVE FOAM

Velostat 2803 has a density of approximately 3 lb./cubic feet and is primarily a cushioning foam, but can be used for pin insertion application with sturdier device leaks.

MOUSER STOCK NO.	Fig.	Size (In.)	Price Per Roll
517-2803-1/4	G	1/4 x 24 x 36	34.65
517-2803-3/8	G	3/8 x 24 x 36	48.98
517-2803-1/2	G	1/2 x 24 x 36	69.45

## VELOSTAT™ FLOOR MATS

A conductive floor mat removes static charge from personnel as they approach work areas. They provide significant passive protection in well-traveled assembly areas. Includes two female snaps (installed) and one 15' ground cord with a one megohm resistor.

MOUSER STOCK NO.	Fig.	Size (Ft.)	Thickness (In.)	Price Each
517-1864-48	H	4 x 8	1/8	279.75

## DISSIPATIVE THREE-LAYER TABLE MATS

3M 8210 series mats have a unique three-layer construction:

The top layer is durable static-dissipative vinyl which has low resistivity to discharge static-laden conductors, yet will prevent the shorting of pins on the backs of printed circuit boards laid on the mat.

The middle layer is a conductive scrim that provides discharge path to ground.

The bottom layer is static-dissipative foam, a durable, nonskid cushion.

Includes 2 female snaps (installed) and one 15' ground cord and ring connector

MOUSER STOCK NO.	Fig.	Color	Size (Ft.)	Price Each
517-8214	I	Blue	2 x 4	93.87

## STATIC-DISSIPATIVE FIELD SERVICE KIT

Designed for field service to manage static and provide safer, more productive work sites.

### 8501 Portable Field Service Kit

#### Features:

- Charge-Guard® adjustable wrist band with 10 ft. coiled ground cord
- Static-dissipative work surface (.021" x 22" x 24") with two 8" x 11" pockets and 5 ft. coiled ground cord

### 8506 Economy Field Service Kit

#### Features:

- Charge-Guard® adjustable wrist band with 5 ft. coiled ground cord
- Static-dissipative work surface (.010" x 15" x 20") with two 6" x 7" pockets and 6 ft. straight ground cord

MOUSER STOCK NO.	Fig.	Description	Price Each	
			(1-4)	(5-UP)
517-8501	J	Portable field service kit	62.70	58.52
517-8506	J	Economy field service kit	39.90	37.29







# Static Control, Coatings, and Specialty Products

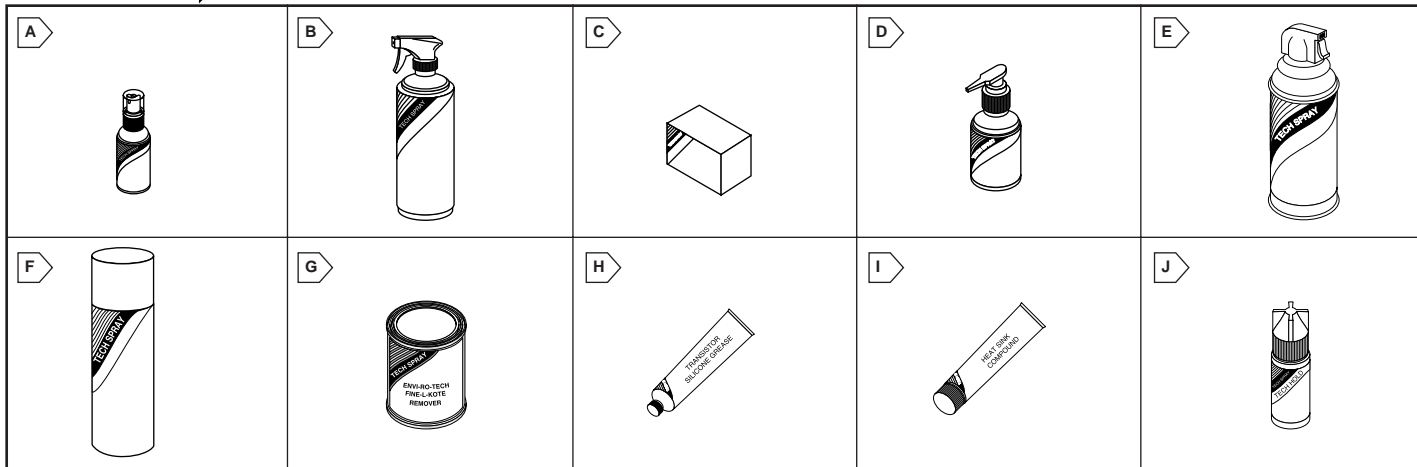

## ETC. STATIC CONTROL FOAM CLEANERS

High foaming action cleans contaminants from glass, plastic, and metal enclosures, without harmful abrasives while providing light static control.

For quantities greater than listed, call for quote.

MOUSER STOCK NO.	Fig.	Size	Price Each
577-1742-2FP	A	2 oz. pump	5.02
577-1742-PT	B	1 pt. trigger	9.27

## ZERO CHARGE™ STATIC CONTROL PRODUCTS

### Mat and Table Top Cleaner

Removes insulating contaminants such as flux residues, oils, greases, nicotine, dirt, and grime. Eliminates charge and prevents static charge build-up.

For quantities greater than listed, call for quote.

MOUSER STOCK NO.	Fig.	Size	Price Each
577-1733-2FP	A	2 oz. pump	5.02
577-1733-PT	B	1 pt. trigger	7.65

### Screen and Keyboard Cleaner

Removes hand oils, ink marks, dust, fingerprints, nicotine, syrup, carbon, and other soils from work areas. Safe on most plastics.

For quantities greater than listed, call for quote.

MOUSER STOCK NO.	Fig.	Size	Price Each
577-1743-50PK	C	50 pkg. box	14.94

### Clean-Room 209 Cleaner

Non-ionic clean-room cleaner that meets federal specification 209 for class 100 and lower. Product cleans and eliminates static charge from sensitive surfaces.

For quantities greater than listed, call for quote.

MOUSER STOCK NO.	Fig.	Size	Price Each
577-1744-2FP	A	2 oz. pump	5.29

## ZERO CHARGE™ STATIC CONTROL PRODUCTS

### Hand Lotion

Formulated with aloe vera for a deep, penetrating, soothing action. Contains no silicone or lanolin. Non-greasy, non-sticky, odorless, and fast absorbing.

For quantities greater than listed, call for quote.

MOUSER STOCK NO.	Fig.	Size	Price Each
577-1702-2SQ	-	2 oz. squeeze	2.68
577-1702-8FP	D	8 oz. pump	4.05

### Anti-Stat Cleaner

Eliminates static charge and reduces triboelectric generation from most surfaces. Recommended for applications that experience flexing and movement and for plastics such as polyethylene, polypropylene, and other similar surfaces.

For quantities greater than listed, call for quote.

MOUSER STOCK NO.	Fig.	Size	Price Each
577-1726-2FP	A	2 oz. pump	5.20
577-1726-PT	B	1 pt. trigger	8.91

### Static Dissipative Treatment

Eliminates static charge and reduces triboelectric generation. Protects up to five times longer than conventional anti-static agents. Should be used on porous surfaces such as corrugated paper, carpets, and other similar materials.

Plus a UPS hazardous material charge per carton.

For quantities greater than listed, call for quote.

MOUSER STOCK NO.	Fig.	Size	Price Each
577-1734-PT	B	1 pt. trigger	9.97

## ENVI-RO-TECH™ ANTI-STATIC FREEZER

100% HFC's, no CFC's, no HCFC's

A rapidly evaporating HFC-134a product that contains an anti-static agent. Zero ozone depletion factor. Used as a trouble shooting aid in static sensitive areas for intermittently faulting capacitors, resistors, semiconductors, and other defective components. Also detects cold solder joints and oxidized junctions.

For quantities greater than listed, call for quote.

MOUSER STOCK NO.	Fig.	Size	Price Each
577-1747-10S	E	10 oz.	7.28

## PROTECTIVE COATINGS

### Fine-L-Kote™ SR

Flexibility allows for vibration, movement, and rapid changes in temperature. Offers chemical resistance and is recommended for harsh environments. Can be reworked by applying soldering iron, or complete removal by using the Fine-L-Kote™ remover (577-1618).



For quantities greater than listed, call for quote.

MOUSER STOCK NO.	Fig.	Size	Price Each
577-2102-12S	F	12 oz.	14.96

### Fine-L-Kote™ AR

Provides insulation against high voltage arcing and corona shorts. Product offers limited resistance to common alcohols, ketones, and esters.

For quantities greater than listed, call for quote.

577-2103-12S	F	12 oz.	12.41
--------------	---	--------	-------

### Fine-L-Kote™ UR

Urethane conformal coating. Highly resistant to most solvents, moisture, and fungus. Can be reworked by applying soldering iron, or complete removal using Fine-L-Kote™ remover (577-1618).

For quantities greater than listed, call for quote.

577-2104-12S	F	12 oz.	13.52
--------------	---	--------	-------

### Fine-L-Kote™ HT

A silicone resin, conformal coating exhibiting excellent adhesion properties. Fine-L-Kote™ HT coating offers complete versatility. Removal can be accomplished with Fine-L-Kote™ Remover (577-1618).

For quantities greater than listed, call for quote.

MOUSER STOCK NO.	Fig.	Size	Price Each
577-2106-12S	F	12 oz.	13.18

## ENVI-RO-TECH™ FINE-L-KOTE™ REMOVER

Removes most conformal coatings, including: acrylic, epoxy, urethane, and some silicones. It can also be used to remove enamels, paints, varnishes, and lacquers. Quickly removes tar, adhesives, crayon, rubber, and carbon.

For quantities greater than listed, call for quote.

MOUSER STOCK NO.	Fig.	Size	Price Each
577-1618P	G	1 pt. metal	15.81

## ENVI-RO-TECH™ CIRCUIT CHILLER

100% HFC's, no CFC's, no HCFC's

A HFC-134a based, rapidly evaporating liquid that chills to minus 62°F. Zero ozone depletion factor. Used as a trouble shooting aid for intermittently faulting capacitors, resistors, semi-conductors, and other defective components. Also detects cold solder joints, cracks in PCB's, and oxidized junctions.

For quantities greater than listed, call for quote.

MOUSER STOCK NO.	Fig.	Size	Price Each
577-1672-10S	E	10 oz.	7.06

## TRANSISTOR SILICONE GREASE

Used to coat the bases of power transistors as they are connected to heat sinks. Heat conductive grease will draw heat away from the transistor allowing it to run cooler.

For quantities greater than listed, call for quote.

MOUSER STOCK NO.	Fig.	Size	Price Each
577-1977	H	1 oz. tube	5.27

## SILICONE FREE, HEAT SINK COMPOUND

A silicone-free compound applied under power transistors and other devices that generate heat to assist in transferring heat from generating objects to metal chassis for dissipation. Temperature range from -40°C to +200°C.

For quantities greater than listed, call for quote.

MOUSER STOCK NO.	Fig.	Size	Price Each
577-1978	I	2 oz. tube	8.42

## TECH HOLD™ GENERAL PURPOSE ADHESIVE

Single component cyanoacrylate adhesive that exhibits high strength, fast bonding, and high impact holding. Having a medium viscosity, flows into small openings (up to .004 inches).

For quantities greater than listed, call for quote.

MOUSER STOCK NO.	Fig.	Size	Price Each
577-2503	J	3 gram	1.62



# PCB Design, Etching, Repair, and Software Products

## GC ELECTRONICS PC BOARD PROTOTYPE PRODUCTION PRODUCTS

### Etching Solution Heater

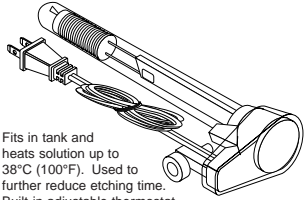

Fits in tank and heats solution up to 38°C (100°F). Used to further reduce etching time. Built-in adjustable thermostat controls temperature continuously to 100°F. 120V AC/100 W Max.

524-22-392	\$16.84
------------	---------

### Etch Resist Ink Pens

Black felt tip pens or making resist circuits directly on PC boards.

#### Features:

- Choice of fine or extra fine tip
- Dries instantly
- Black resist ink

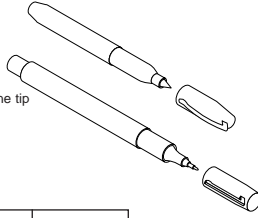

MOUSER STOCK NO.	Tip Size (In.)	Price Each
524-22-220	1/32	2.02
524-22-222	1/64	2.51

### Professional PC Board Power Etching System

A semi-automatic etching device for use in labs, schools, prototype shops and for limited PC board production. Air pump agitates etching solution for fast, even etches. Handles up to two 8" x 10" PC boards at a time, either single or double sided.

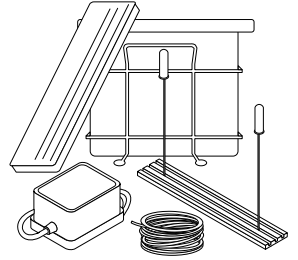

#### Kit Contains:

- 1 Etching Tank and Reservoir Lid (12"H x 2 1/2"W x 10 1/2"L) Molded Polyethylene - ABS PC Board Holder Capacity - 1.25 Gallons of Etching Solution
- 1 Etch-O-Matic Power Agitating Pump, 120V AC Operation
- 1 Permanent or Portable Tip-Free Base
- 1 PC Board Holder and Handle
- 4 Feet of Supply Hose

524-22-394	\$79.04
------------	---------

## TONER TRANSFER SYSTEM

- No Chemicals!
- No Darkroom!
- No Negatives!



#### 3 Easy Steps:

- Print it...
- Iron it...
- Soak it...

Create your own "iron-on" PC board patterns, faceplates, and color decals from any laser printer or high quality copier!

MOUSER STOCK NO.	No. of Sheets	Price Each	
		1	5
5165-TTS5	5	14.95	13.46
5165-TTS10	10	27.95	25.45

## GC ELECTRONICS POSITIVE TYPE DEVELOPER CONCENTRATE

For developing photo sensitized PC boards coated or pre-coated with positive type etch resist.



6 oz.

524-22-226	\$5.05
------------	--------

## GC ELECTRONICS PCS POSITIVE-ACTING ETCH RESIST SENSITIZER

An excellent PC board-making system for the prototype engineer to produce today's high density, fine-line circuit boards. Easy aerosol application covers 5 to 7 square feet.



2.68 oz.

524-22-074	\$12.49
------------	---------

## GC ELECTRONICS SMALL PRINTED CIRCUIT REPAIR KIT

#### Kit Contains:

- 1 solder aid tool (probe)
- 1 low-melt solder
- 1 PC repair foil
- 1 brush
- 1 pair of tweezers
- 2 oz. Print-Kote
- 2 oz. Print-Kote solvent
- Assorted solder washers (fluxed)

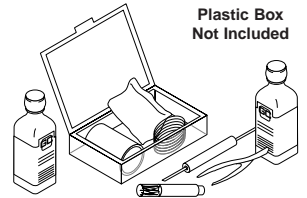

Plastic Box Not Included

524-682	\$22.13
---------	---------

## circuit™ WORKS PCB DESIGN AND REPAIR PRODUCTS

### Conductive Silver Lubrication

Conductive silver grease combines pure silver with advanced lubrication technologies for maximum electrical and thermal conductivity. Protects components from moisture, corrosion and is suitable for low to medium loads and speeds.

- Electronic
- Design
- Prototype
- Repair

Net Weight: .23 oz.



5168-7100	\$13.15
-----------	---------

### Conductive Carbon Lubrication

Conductive carbon grease combines pure carbon graphite with advanced lubrication technologies for electrical conductivity adequate for many applications. Protects components from moisture, corrosion and is suitable for low to medium loads and speeds.

- Electronic
- Design
- Prototype
- Repair

Net Weight: .12 oz.



5168-7200	\$8.75
-----------	--------

### Quick-Bond Gel and Accelerator

A nonmigrating cyanoacrylate gel that provides superior bond strength. Accelerator can be brushed on or applied directly over the gel for reliable, instant bonding.

#### Features:

- Strong, super tough, instant bonding
- Gel formula stays in place and fills gaps
- Bonds most materials, including plastics, rubbers, and metals
- Use where strong, instant bonds are required



5168-4300	\$6.50
-----------	--------

### Overcoat Pens



- A tough coating to protect and insulate components, braces, and repairs on circuit boards
- Dries in minutes at room temperature
- Can be applied over traces made by the conductive pen to protect and insulate trace
- When used to repair solder masks, improves the reliability and safety of circuit board modification

MOUSER STOCK NO.	Color	Price Each
5168-3300C	Clear	10.95
5168-3300G	Green	10.95

### Conductive Pens

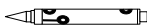

- Use where conductive electronic traces are needed for designing prototype circuits
- Improved conductivity, better trace adhesion, and reduced setting in the pen
- Dries in 3-5 minutes at room temperature
- Spring loaded tip for smooth flow

MOUSER STOCK NO.	Description	Price Each
5168-2200ST	Standard tip	13.15
5168-2200MT	Micro-tip	13.15

### Silver Epoxy Kit

For quick connections and bonding in electronic design, prototype, and repair projects. Bonds to solder, mylar, glass, and copper. Contains (part "A") epoxy, (part "B") hardener, reusable stir/applicator, and instructions. Tube size .25 oz. Use with the conductive and overcoat pens for complete design, prototype, and repair.

- Solderless electronic connections
- Quick no or low heat cure
- Shelf life: 12 months

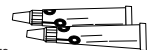

5168-2400	\$16.45
-----------	---------

## GC ELECTRONICS PRINTED CIRCUIT MATERIALS KIT

Includes all the essential materials for making professional printing circuit boards using positive method. Light source not included. The pre-sensitized PC boards are single sided copper clad. **Note:** Kit shipped in two boxes (Part A: kit with paint bi-products; Part B: etching solution). UPS requires a hazardous material surcharge for Part B.

#### Kit Contains:

- 1 PC contact frame
- 1 pre-sensitized PC board (6" x 6")
- 1 pre-sensitized PC board (3" x 4")
- 2 pre-sensitized PC boards (4" x 6")
- 2 mylar sheets (8-1/2" x 11")
- 1 etch resist ink pen
- 2 PC board drill bits
- 1 plastic etching tray (5-1/4" x 7-1/4")
- 1 plastic developing tray (5-1/4" x 7-1/4")
- 6 oz. PC board etching solution
- 2 oz. positive developer concentrate
- 1/2 oz. etch resist lacquer
- 2 oz. PC board stripping solution

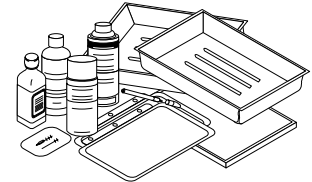

Plus a per carton UPS hazardous material charge

524-22-312	\$54.25
------------	---------

## SOFTWARE FOR PCB DESIGN

### WinDraft

WinDraft is the user friendly schematic capture package for Windows. Install on your PC and in minutes you'll be designing schematics with unsurpassed ease.

#### Minimum System Requirements:

- 486DX based PC
- 8MB RAM
- 10MB hard drive space

- Easily create designs up to 200 pins.
- Expandable to larger designs.
- Compatibility, reads in ORCAD schematics and libraries.
- Industry standard formats for EDIF and ASCII in/out.
- Complete with Elec. Rules Check, Bill of Materials, and over 12,000 parts.
- Comes on two 3.5" HD (1.44M) disks

526-WINDRAFT	\$29.95
--------------	---------

### WinBoard

WinBoard delivers the most sophisticated interactive routing capabilities available under Windows. It supports through hole and SMD designs. Easily create or modify your own modules footprints. Do designs on the fly (place modules and connect them).

#### Minimum System Requirements:

- 486DX based PC
- 8MB RAM
- 10MB hard drive space

- Easily create designs up to 200 pins.
- Expandable to larger designs.
- Compatibility, reads in netlists from WinDraft, ORCAD, Tango, Protel and more.
- Industry standard formats for Gerber photo plot, NC Drill, and Bill of Materials.
- Complete package with DRC, Pick & Place, over 700 modules, and more.
- Comes on two 3.5" HD (1.44M) disks

526-WINBOARD	\$29.95
--------------	---------

# PC Boards and Tools

## FR-4 COMPOSITE

An economical epoxy glass laminate. Suited for applications requiring high strength at low cost. Copper clad one side only.



• .059" thickness

MOUSER STOCK NO.	Board Size (In.)	Price Each
501-FR3X3S	3 x 3	1.06
501-FR4X6S	4 x 6	1.96
501-FR8X10S	8 x 10	6.14
501-FR12X12S	12 x 12	8.36

## LIQUID ETCHANT

Ferric Chloride one of the most widely used liquid etchants for PC board production. Fast acting, very effective, and economically priced. .42° baume. Shipping weight per gallon 15 pounds.

MOUSER STOCK NO.	Price Each Gallon
5161-FECL-B	18.99

Plus a UPS hazardous material charge per shipping carton (This chemical is shipped 1 gallon per carton.)

## DRY ETCHANT

Ammonium Persulphate ideal fast acting powder etchant that you mix with water prior to use. Economical, fast, and effective. Mix ratio: 2 pounds (±10%) of the ammonium persulphate powder to a gallon of water.

MOUSER STOCK NO.	Price Each Pound	
	1 to 9 Lbs.	10+ Lbs.
5161-APS-B	4.94	3.79

Plus a UPS hazardous material charge per shipping carton (Maximum quantity carton 30 pounds.)

## ETCH RESIST INK PEN

### Features:

- Black resist ink
- Fine point
- Felt tip deposits resist directly on copper-clad boards
- Dries instantly

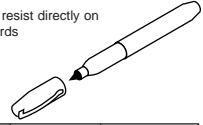

MOUSER STOCK NO.	Tip Size (In.)	Price Each
524-22-220	1/32	2.02

## PRE-PUNCHED COPPER CLAD PC BOARDS

### Features:

- Copper-clad one side
- Pre-patterned "pad-per-hole" design
- .042" diameter holes with 0.1" spacing between holes

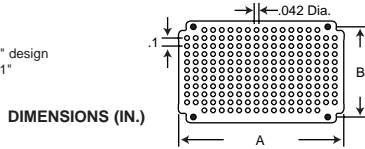

MOUSER STOCK NO.	Dimensions (In.)		Fits Cases	Price Each				
	A	B		1	10	25	50	100
400-9032	2.44	1.46	400-5032 and 400-6032	2.89	2.41	2.19	1.99	Call For Quote
400-9043	3.03	1.85	400-5043 and 400-6043	3.86	3.22	2.93	2.66	
400-9053	3.86	2.40	400-5053 and 400-6053	5.06	4.22	3.84	3.49	
400-9064	4.96	2.99	400-5064 and 400-6064	7.00	5.83	5.30	4.82	

## PROTOTYPING GRID BOARDS

### Features:

- Pre-punched
- .042" hole diameters
- 1/16 (.06) thickness
- High quality

DIMENSIONS (IN.)

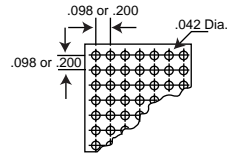

### 2.5mm/.098" Grid Spacing

MOUSER STOCK NO.	Width (In.)	Length (In.)	Copperclad	Price Each			
				1	10	50	100
153-1108	5.91	7.87	None	9.76	8.13	7.39	Call For Quote
153-1112	5.91	11.81	None	12.50	11.36	10.33	
153-1120	5.91	19.69	None	21.54	19.58	17.80	
153-1220	5.91	19.69	1 Side	29.28	26.62	24.20	

### .200" Grid Spacing

MOUSER STOCK NO.	Width (In.)	Length (In.)	Copperclad	Price Each			
				1	10	50	100
153-1122	5.91	19.69	None	17.51	15.92	14.47	Call

## PLUG BOARDS

### Features:

- Available in Y matrix or "pad-per-hole" design
- For edge card, eurocard or plan
- Copper-clad one side
- .100" grid spacing
- 0.42" hole diameters
- 1/16 (.06) thickness
- High quality epoxy paper
- 37 hole wide

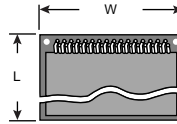

A

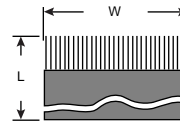

B

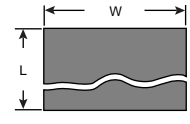

C

MOUSER STOCK NO.	Fig.	Description	Type	Width (In.)	Lth. (In.)	Price Each			
						1	10	50	100
153-1307	A	Pad-per-hole, for 32 pin eurocard	AA	3.94	6.29	13.46	12.24	11.13	Call For Quote
153-1309	B	Pad-per-hole, .100 card edge fingers	AA	3.94	6.29	13.46	12.24	11.13	
153-1318	C	Y matrix with continuous holes	BB	3.94	6.29	11.73	10.66	9.69	
153-1322	C	Y matrix with continuous holes	BB	3.94	19.69	33.26	30.24	27.49	

## Bishop Graphics, Inc. DRAFTING SYMBOLS

### PC Design Template 1X

Contains 9 axial lead and 7 radial lead components, 5 transistor and 7 potentiometer outlines; various lead patterns on .200", .230", & .400" centers, flat pack, and DIP outlines; .100", .125", .156" spaced connector strip patterns; 5 scale size: 5" x 6" x .030" thick. Pencil allowance: .025"

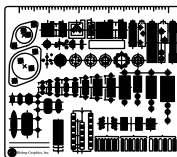

MOUSER STOCK NO.	Price Each
508-3365	38.21

### Electrical and Electronic Diagrams Template

Complies with ANSI Y32.2 and IEEE standard No. 315. All popular schematic and logic symbols needed to produce most electronic diagrams. For use on a .200" grid. Size: 7" x 5" x .030" thick.

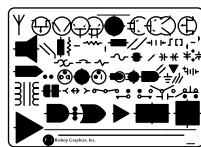

MOUSER STOCK NO.	Price Each
508-3378	20.06

## DUAL-IN-LINE SYMBOLS

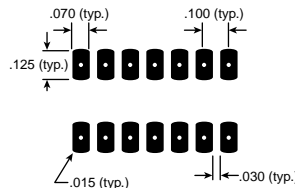

DIMENSIONS (IN.)

MOUSER STOCK NO.	Size	Pins	Qty.	Price Per Pkg.
508-6014	1x	14	250	57.12
508-6038	2x	14	250	57.12
508-6004	1x	16	250	57.12
508-6109	2x	16	250	57.12
508-6535	1x	24	100	57.12
508-6536	2x	24	100	57.12

## DONUT PADS

Serve as the basic termination area for prototyping and PC artwork. 500 per package

MOUSER STOCK NO.	O.D. (In.)	I.D. (In.)	Price Per Pkg.
508-D136	.062	.025	23.28
508-D137	.093	.031	23.28
508-D101	.100	.031	23.28
508-D102	.125	.031	15.36
508-D138	.187	.031	15.36
508-D141	2.50	.031	15.36
508-D114	.375	.062	19.54

## BLACK TAPE

20 yard rolls

MOUSER STOCK NO.	Tape Size (In.)	Price Per Roll
508-201-031-11	.031	6.38
508-201-040-11	.040	6.38
508-201-050-11	.050	6.38
508-201-062-11	.062	6.43
508-201-100-11	.100	6.43
508-201-125-11	.125	6.82

## EAGLE PCB CARD GUIDES

The printed circuit board card guide is designed to fit a .125" + .003" -.001" front diameter hole and a .120" ± .005 x .218" slot rear hole.

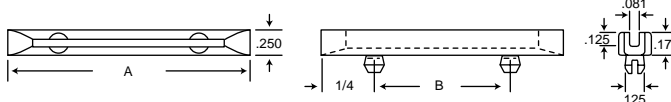

DIMENSIONS (IN.)

MOUSER STOCK NO.	Dimensions (In.)		Price Each			
	A	B	1	100	500	1000
561-CG250	2.5	2.0	.49	.368	.336	.305
561-CG300	3.0	2.5	.49	.368	.336	.305
561-CG350	3.5	3.0	.49	.368	.336	.305
561-CG400	4.0	3.5	.55	.420	.378	.347
561-CG450	4.5	4.0	.59	.438	.402	.365
561-CG550	5.5	5.0	.56	.420	.378	.347
561-CG600	6.0	5.5	.63	.473	.431	.389





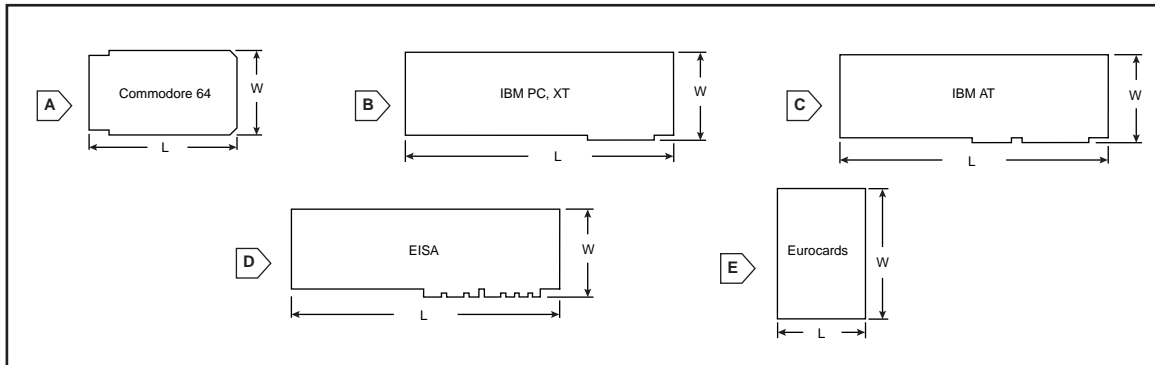

## VECTORBORD® BUS SPECIFIC PLUGBOARDS™

Boards have bus specific architecture. They can be used for wirewrap or solder terminations. Holes and edge contacts are positioned on 0.1" centers. Power and ground buses are committed to connectors per bus specifications. Layout paper and instructions are included.

MOUSER STOCK NO.	Fig.	Dimensions (In.)		Hole Dia. (In.)	16 Pin DIP Capacity	Material	Bus	Circuit Pattern	Price Each	
		W	L						1	10
574-3795-1	A	2.73	4.50	.042	4	CEM1 Epoxy glass comp.	Commodore 64	3 hole solder pad	21.43	20.38
574-4613	B	4.20	13.23	.042	44	FR4 Epoxy glass	IBM PC, XT	3 hole solder pad	63.60	60.48
574-4613-1	B	4.20	13.23	.042	84	FR4 Epoxy glass	IBM PC, XT	Peripheral buses	49.42	46.99
574-4613-2	B	4.20	13.23	.042	55	FR4 Epoxy glass	IBM PC, XT	Voltage / ground planes	63.60	60.48
574-4613-3	B	4.20	13.23	.042	91	FR4 Epoxy glass	IBM PC, XT	Pad-per-hole, plated thru holes	49.95	47.49
574-4617	C	4.80	13.25	.042	32	FR4 Epoxy glass	IBM AT	3 hole solder pad, plated thru holes	63.60	60.48
574-4617-1	C	4.80	13.25	.042	108	FR4 Epoxy glass	IBM AT	Peripheral buses	51.90	49.35
574-4617-3	C	4.80	13.25	.042	96	FR4 Epoxy glass	IBM AT	Pad-per-hole, plated thru holes	63.60	60.48
574-4617-4	C	4.80	13.25	.055	140	FR4 Epoxy glass	IBM AT	Voltage / ground plane	63.60	60.48
574-4617C5LF	C	4.80	13.25	.055	140	FR4 Epoxy glass	IBM AT	Fully populated with wire wrap pins	484.12	459.92
574-4607	A	5.19	8.43	.042	85	FR4 Epoxy glass	DEC	Contacts only	38.62	36.72
574-4619-3	D	4.50	13.25	.042	70	Mult. layer	EISA	Pad-per-hole, plated thru hole	168.69	160.39

## VECTORBORD® EUROCARD METRIC VME PROTOTYPING BOARDS (DIN 41612)

Feature precision-drilled holes and FR4 epoxy glass construction. They are compatible with VME, Multibus 11, Future Bus, and most common DIN-based applications. Bus connector areas designed for standard 96 pin DIN connectors.

MOUSER STOCK NO.	Fig.	Dimensions (In.)		Hole Dia. (In.)	16 Pin DIP Capacity	Material	Circuit Pattern	Wire Wrap Pins	Price Each	
		W	L						1	10
574-E160-3U-3	E	6.30	3.94	.055	45	FR4 Epoxy glass	Voltage / ground plane	R50, R51, R53	32.09	30.51
574-E160-6U-1	E	6.30	9.19	.042	100	FR4 Epoxy glass	Pad-per-hole with plated thru holes	574-R32/C	51.43	48.90
574-E160-6U-3	E	6.30	9.19	.055	105	FR4 Epoxy glass	Voltage / ground plane	R51, R52, R53	54.00	51.35
574-E220-6U-1	E	8.66	9.19	.042	140	FR4 Epoxy glass	Pad-per-hole with plated thru holes	574-R32/C	68.10	64.75
574-E220-6U-3	E	8.66	9.19	.055	168	FR4 Epoxy glass	Voltage / ground plane	R51, R52, R53	65.52	62.29
574-E280-9U-3	E	11.02	14.44	.055	348	FR4 Epoxy glass	Voltage / ground plane	R51, R52, R53	90.14	85.70

### Circuit Pattern

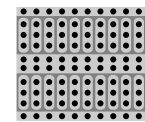

3-Hole solder pad pattern

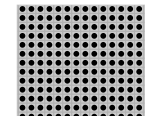

Peripheral buses

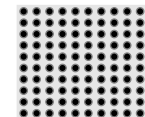

Voltage/ground plane patterns

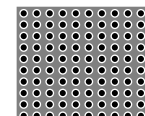

Pad-per-hole pattern

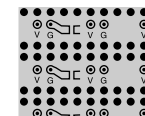

VECTORBORD plus pattern Fully populated with wire wrap pins

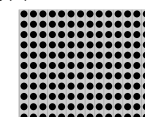

Contacts only pattern

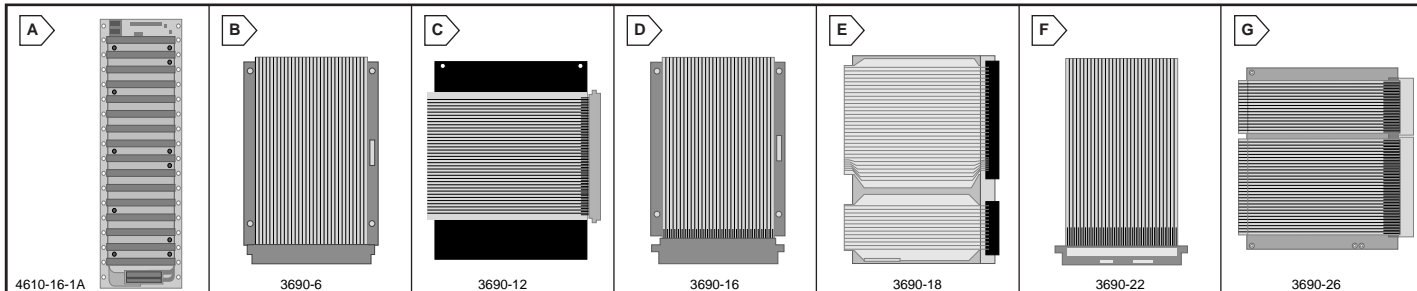

## VECTORBORD® STANDARD BUS BACKPLANE

Fully assembled and tested, 16 slot backplane for standard bus applications. Connector spacing is on .75" centers. Meets all standard bus specifications.

\* Power lines are filtered with bypass capacitors

MOUSER STOCK NO.	Fig.	Dimensions (In.)			Connector Spacing	Accessories			Contacts	Price Each	
		W	L	T		Plugbord Series	Extender	Card Rack		1	10
574-4610-16-1A	A	4.35	13.00	.062	.750	4610 series	3690-16	CCK13 series	Gold plated	254.48	242.15

## VECTORBORD® GENERAL PURPOSE AND BUS SPECIFIC EXTENDER CARDS

Extenders for in-system testing of functioning circuits. Construction is either FR4 epoxy glass or epoxy glass composite with nickel / gold plated edge contacts and gold plated socket contacts. Connectors are installed and attached to 2-once etched circuit line on the board. Connector tabs on most models are designed to accept test clips or probes.

\* Power lines are filtered with bypass capacitors

MOUSER STOCK NO.	Fig.	Dimensions (In.)		Spacing	No. of Contacts	Material	Bus	Price Each	
		H	W					1	10
574-3690	B	6.50	4.50	.156	44	Epoxy glass composite	General purpose	34.91	33.20
574-3690-4	B	7.50	4.50	.100	72	Epoxy glass composite	General purpose	64.45	61.28
574-3690-6	B	11.00	4.50	.156	44	Epoxy glass composite	General purpose	41.06	39.01
574-3690-12	C	7.50	10.00	.125	100	Epoxy glass composite	S100	66.38	63.11
574-3690-16	D	6.50	4.50	.125	56	Epoxy glass composite	General purpose/standard	43.23	41.10
574-3690-18	E	7.65	12.00	.100	60	Epoxy glass	Multibus 1	95.00	90.33
574-3690-22	F	5.70	3.18	.100	62	Epoxy glass	IBM PC, XT	57.76	54.92
574-3690-26	G	5.60	6.70	.100	36	Epoxy glass	IBM AT	66.38	63.11
574-3690-30	H	7.475	6.10	DIN	96	Multilayer	PS/250, 60	205.86	195.57
574-3690-31	I	7.475	7.65	DIN	96	Multilayer	PS280	237.77	226.08
574-3690-32	J	5.60	6.70	.050	188	Multilayer	*EISA	258.19	245.49
574-VMEE-J1	K	3.94	12.20	DIN	96	Multilayer	VME	255.82	243.24
574-VMEE-J2	K	3.94	12.20	DIN	96	Multilayer	VME	255.82	243.24

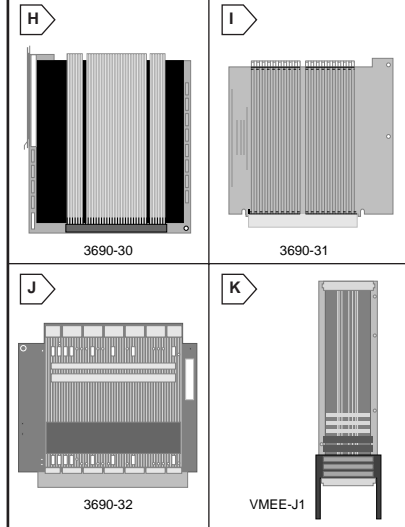

## PCI DEVELOPERS KITS AND PCMCIA PROTOTYPE KITS

### 4624-10 PCI Developer's Kit

- Provides prototype space and additional boards and accessories for circuit layout
- Compliant with PCI Spec 2.1 providing Busmastering functions
- Chip and kit documentation included
- Kit Contents: 2 PC boards that plug into PCI board, PCI prototype board with AMCC Matchmaker bus controller chip with provisions for flash memory and memory for software use, ISA "Loopback" PC card for interface with same or other PC, test and development software, chip and kit documentation (schematics and circuit layout drawings) and quick reference guide

574-4624-10 **\$495.00**

### 4624-8 PCI Prototype Board for Circuit Development

- Full size PCI card allowing expanded space for circuit layout
- Compatible with Power PC Macintosh and PC formats
- AMCC Matchmaker bus controller chip installed and tested on PCI card
- Software and documentation provided

574-4624-8 **\$295.00**

### 4624-3 PCI Prototype Board for Universal Development

- Multilayer board with pad per hole pattern with power and ground accessible throughout board
- Designed for use in 5 volt or 3.3 volt applications
- Designed for use with Vector prototype accessories
- Instructions included

574-4624-3 **\$135.34**

### 3690-34-3V PCI Test Extender

- 32 bit or 64 bit test extender card for 3.3 volts
- Each signal line provided with test point
- Assembled and tested
- Instructions included

### 3690-34-5V PCI Test Extender

- 32 bit or 64 bit test extender card for 5 volts
- Each signal line provided with test point
- Assembled and tested
- Instructions included

574-3690-34-3V **\$225.00**  
574-3690-34-5V **\$225.00**

### 4625-3 PCMCIA Prototype Board Kit

- Large area 10.6" x 7" prototype board
- FR4 epoxy glass board
- 0.1" grid pattern with pad per hole, surrounded by ground and power planes on both sides of board
- Kit Contents: PCMCIA adaptor, 10.6" x 7" prototype board

574-4625-3 **\$125.00**

### 3690-35 PCMCIA Test Extender

- Designed for Type I and Type II use
- 64 pin connect or with numbering
- Multilayer construction
- Signal lines provided with test points
- Assembled and tested

574-3690-35 **\$135.00**

**NEW IN '97**

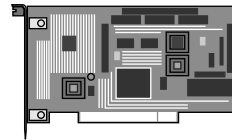

4624-10

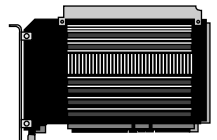

3690-34-3V, 3690-34-5V

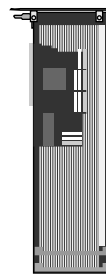

4624-8

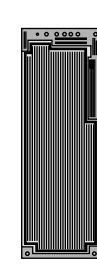

4624-3

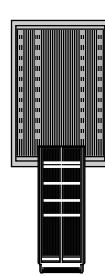

4625-3

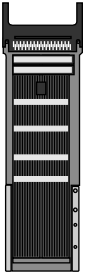

3690-35

## PAD CUTTER

Pad cutters provide an effective method for creating isolated solder pads around holes in copper clad boards. Pilot pin enters hole and rotated, creating a clearance area around solder pad.

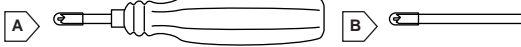

MOUSER STOCK NO.	Fig.	Description	Price Each
574-P138A	A	With handle, for pattern P, .042" holes	20.90
574-P138C	B	Shank only, without handle, for use in power drills	17.11

## WIRE-WRAP TOOLS

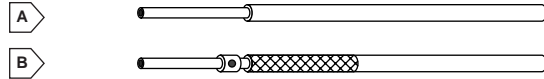

MOUSER STOCK NO.	Fig.	Description	Price Each
574-P160-1B	A	Manual unwrap tool for 26AWG - 30AWG wire	60.59
574-P160-2B	B	Manual wrapping tool for 26AWG - 30AWG wire	41.97

## TEFZEL INSULATED SILVER PLATED WIRE

This wire is designed to be used with wire wrap terminals. Spool diameter is 1 inch.

MOUSER STOCK NO.	AWG	Color	Ft. Per Spool	Spools Per Pkg.	Price Per Pkg.
574-W28-6A	28	Green	50	2	16.12
574-W28-6B	28	Red	50	2	16.12
574-W28-6D	28	Blue	50	2	15.28
574-W28-6E	28	White	50	2	16.31
574-W28-6F	28	Yellow	50	2	15.28
574-W28-6H	28	Black	50	2	16.55

**NEW IN '97**

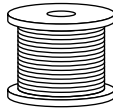

## MULTI-MOD CASE

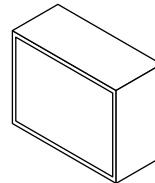

Versatile multi-mod case is ideal for small case packaging of testers, controllers, and other instruments. Brushed aluminum construction provides excellent RF attenuation. Extruded, two piece frame assemblies quickly with self tapping screws. Fits standard .062" cards.

MOUSER STOCK NO.	Dimensions (In.)			Card Size (In.)	Price Each
	H	W	L		
574-W20-66-46B	4.61	2.00	6.61	6.50 x 4.50	24.55

## PINS, TERMINALS, SOLDER EYELETS, AND BUS STRIPS

### Mini-Klip™ Push-In Terminals

DIMENSIONS (IN.)

MOUSER STOCK NO.	Fig.	Description	Package Quantity	Price Each
574-T28/M	A	Push-in terminal for .062" holes	1000	36.50
574-T42-1/C	B	Push-in terminal for .042" holes	100	5.32
574-T42-1/M	B	Push-in terminal for .042" holes	1000	38.10
574-K24A/M	C	Pin .650" (L) for .042" hole, gold plated	1000	89.34
574-K24C/M	C	Pin .650" (L) for .042" hole, tin plated	1000	49.14
574-K30C/M	D	Pin .550" (L) for .042" hole	1000	31.05
574-K31C/M	D	Pin .375" (L) for .042" hole, tin plated	1000	34.76
574-K32/C	E	J pin terminal for .042" holes	100	12.93

### .025" Square Post Wire-Wrap Terminals

574-T44/C	F	Bifurcated with 2 pronged receptacle for wires or leads	100	6.34
574-T44/M	F	Bifurcated with 2 pronged receptacle for wires or leads	000	38.10
574-T46-2-9/M	G	Press in terminal for .042" hole; A=.36", B=.42"	1000	66.06
574-T46-3-9/C	G	Press in terminal for .042" hole; A=.46", B=.60"	100	9.47
574-T46-3-9/M	G	Press in terminal for .042" hole; A=.46", B=.60"	1000	71.83
574-T46-4-9/C	G	Press in terminal for .042" hole; A=.04", B=.42"	100	6.46
574-T46-4-9/M	G	Press in terminal for .042" hole; A=.04", B=.42"	1000	48.52
574-T46-5-9/C	G	Press in terminal for .042" hole; A=.28", B=.60"	100	7.97
574-T46-5-9/M	G	Press in terminal for .042" hole; A=.28", B=.60"	1000	65.37
574-T49/C	H	Trifurcated with 3 pronged receptacle for wires or leads	100	11.64
574-T49/M	H	Trifurcated with 3 pronged receptacle for wires or leads	1000	102.76
574-T68/C	I	Bifurcated mini-wrap terminal length .80	100	6.12
574-T68/M	I	Bifurcated mini-wrap terminal length .80	1000	32.59
574-T68A/M	I	Bifurcated mini-wrap terminal length .63	1000	45.33

### .042" Wire-Wrap Socket Pins

• Low profile • Pressfit mounting

574-R32/C	J	Four finger contacts, depth .13"	100	28.45
574-R32/M	J	Four finger contacts, depth .13"	1000	193.97

### Solder Eyelets and Bus Strips

574-T123/500	K	Solder eyelets for .055" holes	500	26.45
574-T107/C	L	.08" (W) x 14" (L) solder-coated	100	78.80

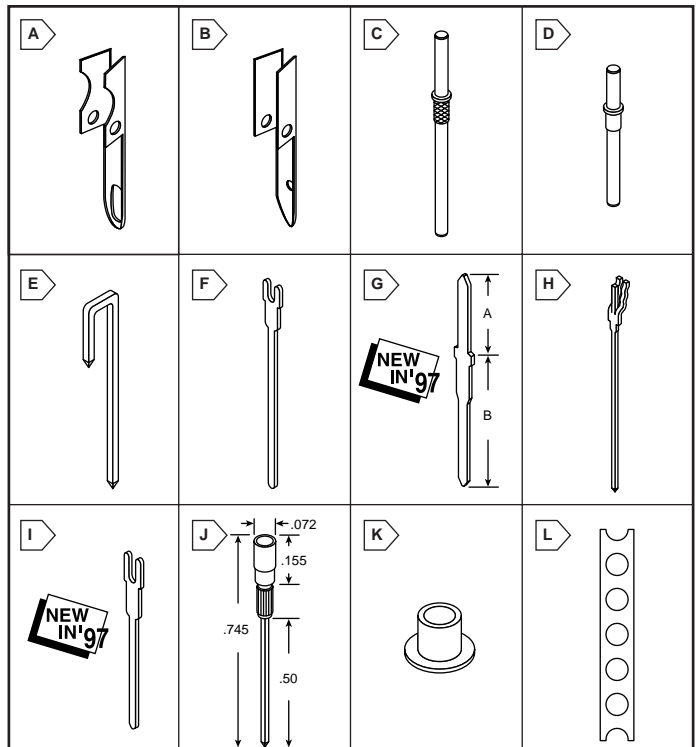

# Breadboards, Accessories, and Tools

## 3M SOLDERLESS BREADBOARDS

3M solderless breadboards incorporate state-of-the-art techniques in design and fabrication to yield a circuit building system with unparalleled flexibility.

### Features:

- 5 way binding post interface connections
- Laboratory proven multi-tie point terminal design
- Steel base with high gloss baked enamel finish
- Alpha-numeric tie-point identification
- 3M jumper wires included with all breadboards

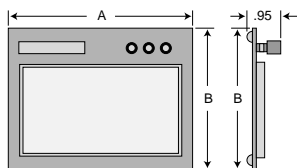

MOUSER STOCK NO.	DIP Capacity	Size (In.)		No. of Tie Points	Binding Post	Price Each
		A	B			
517-922306	6-14 pin	5.4	4.0	610	2	10.80
517-922309	9-14 pin	7.0	4.0	840	3	15.80
517-922318	18-14 pin	7.75	6.25	1824	3	29.14
517-922327	27-14 pin	8.0	9.25	2712	4	37.47
517-922336	36-14 pin	10.25	9.25	2648	4	55.81
517-922345	45-14 pin	12.44	9.75	4520	4	74.98
517-922354	54-14 pin	14.69	9.75	5424	4	83.32

## 3M COLOR CODED JUMPER WIRES

### Features:

- Pre-measured, pre-formed color coded jumper wires
- Stripped 1/4", bent 90° on both ends
- 22 AWG solid, tinned copper, PVC insulated

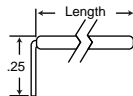

MOUSER STOCK NO.	Length (In.)	Color	Package Quantity	Price Each
517-923345-01	0.1	None	200	4.64
517-923345-02	0.2	Red	200	4.64
517-923345-03	0.3	Orange	200	4.64
517-923345-04	0.4	Yellow	200	4.64
517-923345-05	0.5	Green	200	4.64
517-923345-06	0.6	Blue	150	4.64
517-923345-07	0.7	Violet	150	4.64

MOUSER STOCK NO.	Length (In.)	Color	Package Quantity	Price Each
517-923345-08	0.8	Gray	150	4.64
517-923345-09	0.9	White	150	4.64
517-923345-10	1.0	Brown	100	4.64
517-923345-20	2.0	Red	100	4.64
517-923345-30	3.0	Orange	75	4.64
517-923345-40	4.0	Yellow	75	4.64
517-923345-50	5.0	Green	75	4.64

## 3M COLOR CODED JUMPER WIRE ASSORTMENT KIT

- 350 pieces
- 14 different color coded lengths
- 25 of each length

MOUSER STOCK NO.	Price Each
517-923351R	20.18

**A**

383-K326 Shown

- Programmable 25-pin detachable I/O D-sub connectors included (1 male, 1 female)

**B**

- Built-in power supply (short-proof)
- DC power: +5V/1A
- Adjustable: 0 to +15V or -15V @ 500mA

**C**

**D**

- All PC signals are connected to PCB
- External DB-25 D-sub connector (female) for interfacing

## PP PROTO-TYPE BOARDS

For construction of electronic circuits. Accepts most electronic components including IC's and transistors. Contacts-silver/nickel alloy. ABS polymer plastic body. Edge plates included. Dimensions shown are base plate dimensions.

MOUSER STOCK NO.	Fig.	Description	Dimen. (In.)		Price Each
			L	W	
383-K158	A	1580 tie points, 3 binding posts, fits up to 18 14-pin dual-in-line IC's	6.625	7.50	21.45
383-K242	A	2420 tie points, 4 binding posts, fits up to 27 14-pin dual-in-line IC's	9.875	7.375	32.19
383-K326	A	3260 tie points, 4 binding posts, fits up to 36 14-pin dual-in-line IC's	10.50	9.50	47.39
383-K2300-1	B	Interface proto-type board, 2320 tie points, 4 binding posts, fits up to 36 14 pin dual-in-line IC's	10.00	9.00	58.95
383-K2400	C	Powered proto-type board, input line voltage: AC 120V 60Hz, 2420 tie points, power switch w/light	9.75	7.75	159.95
383-Q1940	D	PC interface proto-type board, 1940 tie points, fits up to 24 14-pin dual-in-line IC's	13.75	4.00	91.88

## PP MULTI-BOARD SOCKETS AND BUS STRIPS

### Features:

- Center channel can be adjusted from 0.3 to 0.6 with a simple swap of the strips
- Accommodates 8 to 40 pin IC's
- Can fit up to 9 14-pin dual-in-line IC's
- Snap lock design allows easy combination with other strips

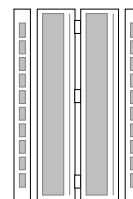

MOUSER STOCK NO.	Price Each
383-X1000	10.95

## PP SOCKET AND BUS STRIPS

### Features:

- External body is made of polymer which resists heat up to 90°C
- Internal contact material is made of silver and nickel alloy
- Contact resistance: < 1mΩ
- Snap lock design allows easy combination with each other for greater design flexibility

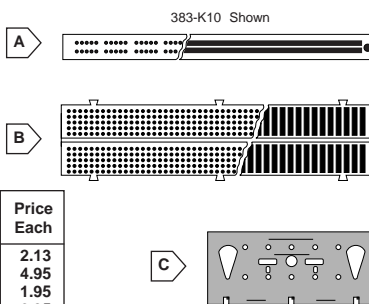

MOUSER STOCK NO.	Fig.	Description	Dimen. (In.)		Price Each
			L	W	
383-Q50	A	2 buses of 25 terminals in two rows	3.15	.47	2.13
383-Q290	A	58 groups of 5 connected terminals	3.15	1.5	4.95
383-K10	A	4 buses of 25 terminals in two rows	6.8	.54	1.95
383-K64	B	128 groups of 5 connected terminals on each side	6.8	1.5	6.95
383-EP3	C	Edge plate allows easy mounting of components	6.8	2.5	.78

## PP SOLID JUMPER WIRE

### Features:

- Replacement wire for jumper wire assortment kit, part number: 383-1425
- Each wire is stripped 1/4" and bent 90° on both ends
- PVC insulated #22 AWG solid tinned copper
- 14 color coded sizes from 0.1" to 5.0"

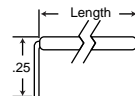

MOUSER STOCK NO.	Length (In.)	Color	Pkg. Qty.	Price Each
383-KS01	0.1	(no insulation)	200	3.94
383-KS04	0.4	Yellow	200	3.94
383-KS06	0.6	Blue	150	3.94
383-KS10	1.0	Brown	100	3.94

## X-ACTO TOOLS

### 6 1/2" Long Tweezer

MOUSER STOCK NO.	Fig.	Description	Price Each
5877-X73380	A	Nickel plated steel, self closing and blunt serrated points	4.28

### Mini Vacu-Vise

MOUSER STOCK NO.	Fig.	Description	Price Each
5877-X73700	B	Holds tight instantly on nonporous surfaces, glass, metal formica, etc. No screws, just flip the lever!	8.09

### Knife

MOUSER STOCK NO.	Fig.	Description	Price Each
5877-X3001	C	5" long knife with aluminum handle	2.75

### Blades

MOUSER STOCK NO.	Fig.	Description	Price Each
5877-X11	D	No. 11 blade, package of 5	1.70

### Hot Knife

MOUSER STOCK NO.	Fig.	Description	Price Each
5877-X6278	E	Threaded end screws into Weller marksman soldering iron 578-SP23 and cuts through plastics rapidly and accurately.	3.14

### Knife Assortment Kit

MOUSER STOCK NO.	Fig.	Description	Price Each
5877-X5082	F	Comes complete with fitted chest and #1, 2, and 5 knives plus 10 assorted extra blades	18.68



## 5002 UNIVERSAL COUNTER

- Frequency, period, ratio, pulse width, and count modes
- 1.3GHz maximum frequency
- AC or battery operation
- Selectable gate times 0.1, 1, 10 seconds
- High resolution reciprocal measurement
- Portable with detachable AC line cord
- Trigger level control and low pass filter
- External standard input with auto-change over
- Three year warranty

**NEW IN '97**

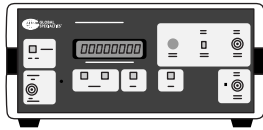

510-5002 \$499.95

## MODEL 5003 FREQUENCY COUNTER

- 1.3GHz hand held frequency counter
- 5Hz to 1300MHz frequency range
- Very high sensitivity at all frequencies
- Frequency and period measurement, 0.0001MHz resolution
- Reciprocal counting technique gives superior accuracy
- Push-to-measure function with auto power-down
- Large 8-digit display with full range of indicators
- Three year warranty

**NEW IN '97**



510-5003 \$250.00

## 2002D FUNCTION GENERATOR

- 2MHz multi-purpose sweep function generator with internal 8-digit frequency counter
- Wide frequency range 0.2Hz to 2MHz
- Provides sine, triangle, square wave, and ramp outputs
- Continuously variable 50Ω output
- Variable DC offset
- Symmetry control
- Separate TTL output provides duty-cycle adjustment
- Sweep input allows VCO control of frequency
- Model 2002 available without digital display
- Three year warranty

**NEW IN '97**

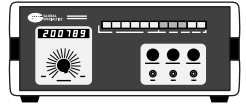

510-2002 \$280.00

## MODEL 1302B DC POWER SUPPLY

The 510-1302A features three completely isolated voltage supplies: a fixed/variable 5 VDC, 5.0A output, two variable 0-30 VDC, 2.0A outputs are available via front panel, and color-coded binding posts. The separate front panel 3 inch LED displays allow you to monitor voltage from 0-30V and current from 0-2A.

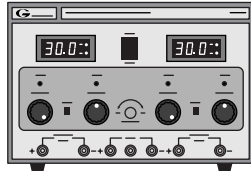

• Three Year Warranty

510-1302 \$525.00

## MODEL 1310 DC POWER SUPPLY

Three independent outputs—one fixed: +5V; two variable: 1.2-20V. +5VDC @ 1 amp, variable supplies .25 amp each. LED readout for voltage or current on either variable supply. External short circuit will not damage supplies. All supplies are floating and transformer isolated. Size: 3H x 10W x 7D inches. Weight: 6 lbs.

• Three year warranty

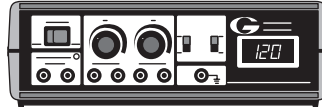

510-1310 \$174.00

## 2003 FUNCTION GENERATOR

- Fully synthesized
- DC to 1.6 MHz
- Trigger, sweep, burst, hop, gate, and continuous modes
- Internal linear/log sweep across frequency range
- External trigger and gate
- TS232 communications port
- Three year warranty

**NEW THIS YEAR**

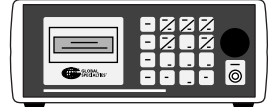

510-2003 \$525.00

## 1316/1332 POWER SUPPLIES

- Model 1316: 0-16VDC @ 0-10A
- Model 1332: 0-32VDC @ 0-5A
- Laboratory grade single output supplies
- Short circuit protected
- Digital readout monitors current and voltage
- Coarse and fine adjustments
- Heavy duty transformer isolated design
- Constant current/voltage mode LED indicators
- Three year warranty

**NEW IN '97**



510-1316 \$390.00  
510-1332 \$360.00

## 1504/1505 AC POWER SUPPLIES

- Model 1504 Single Range: 0-150VAC @ 4A
- Model 1505 Dual Range: 0-150VAC @ 4A, 0-260VAC @ 2A
- Triple isolated continuously variable AC output
- Power line leakage current measurement facility
- 3-digit DPM for high accuracy
- Capacitive coupling less than 0.0005pF
- Galvanic leakage less than 10µA
- 120dB attenuation for common mode noise
- Three year warranty

**NEW IN '97**

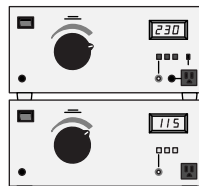

510-1504 \$425.00  
510-1505 \$610.00

## 4001 PULSE GENERATOR

- Independent settings of pulse width and pulse spacing
- Outputs from 0.5Hz to 5MHz
- Complement output-inverts waveform
- Variable output for CMOS circuitry
- Symmetrical square wave outputs
- Four modes-run, triggered, gated, one-shot
- Power regulated: 105-135AC, 57-63Hz, 6VA maximum waveform
- Sizes (H x W x D): 3" x 10" x 7", weight: 2.2 lbs.
- Three year warranty

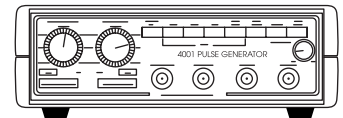

510-4001 \$210.00

## UNPOWERED PROTO-BOARDS™

- 510-PB-10**
- 840 tie points
  - 3 binding posts
  - Plastic backplate
  - 7 x 4 x 1.4 inches (L x W x H)
  - 8 14pin DIP cap

**NEW THIS YEAR**

- 510-04-1050**
- Largest breadboard available
  - 4560 tie points
  - 5 binding posts
  - Aluminum backplate
  - 9.2 x 11.4 x 1.4 inches (L x W x H)
  - Contact resistance: less than .5mΩ
  - 48 14-pin DIP capacity

- 510-PB-103**
- 2250 tie points
  - 4 binding posts
  - Aluminum backplate
  - 9 x 6 x 1.4 inches (L x W x H)
  - 24 14pin DIP cap

**NEW THIS YEAR**

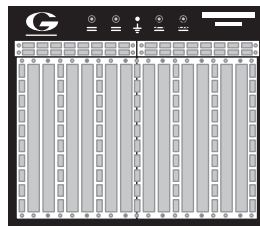

510-04-1050

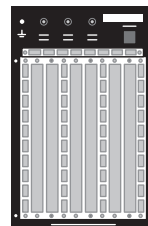

510-PB-103



510-PB-10

**Unlimited Lifetime Guarantee On All Global Breadboard Sockets**

510-PB-10 \$17.44  
510-PB-103 \$44.00  
510-04-1050 \$95.00

## POWERED PROTO-BOARDS™

- PB-503:**
- 1 to 100KHz function generator and TTL outputs
  - Voltage: 5V and variable ±5-15VDC power supplies
  - 2520 tie-points
  - 8 logic probe circuits, LED indicators, pulsers, potentiometers and speaker
  - Bench-top workstation

- PB-503C:**
- Identical to PB-503 in portable design workstation
  - Housed in a rugged carrying case

**NEW THIS YEAR**

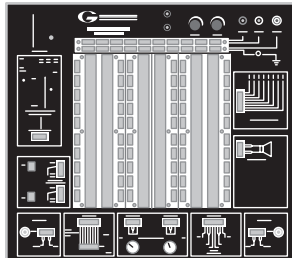

PB-503 Series

- PB-203A:**
- 5VDC, 1A power supply
  - Separate +5.5-18VDC/-5.5-18VDC power supplies-capable of 500mA @ 15VDC
  - Factory pre-set power to +/15VDC
  - Voltages independently adjustable
  - Twenty four 14 pin DIP capacity

- PB-203AK:**
- Identical to PB-203A in kit form
  - 30-page construction manual

- PB-204:**
- 5VDC, 1A power supply
  - Separate +12/-12VDC power supplies-capable of 250mA
  - Powered from external pak twenty four 14 pin DIP capacity

**Unlimited Lifetime Guarantee On All Global Breadboard Sockets**

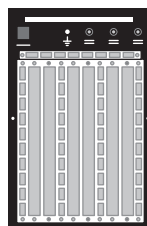

PB-200 Series

MOUSER STOCK NO.	Weight (lb.)	Price Each
510-PB-503	7	299.95
510-PB-503C	7.8	349.95
510-PB-203A	5.5	183.00
510-PB-203AK	5.5	129.95
510-PB-204	5	121.00

## CIRCUIT SIMULATOR SOFTWARE

Introducing Protolab™ a total computer-simulated, electronics laboratory including free built-in test instruments and tools to build and test actual circuits.

### System Requires:

- IBM/PC or compatible with 512K RAM
- EGA/VGA video
- Mouse
- 3-1/2" or 5-1/4" floppy drive

### Includes:

- Protolab™ Release 3.2
- 3 Protoware™ modules (diodes, transistor amplifiers, and electronic organs)

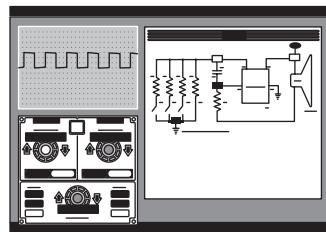

Electronic Organ

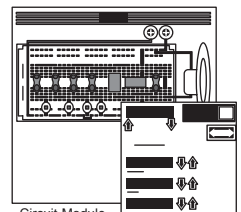

Circuit Module

Signal Generator

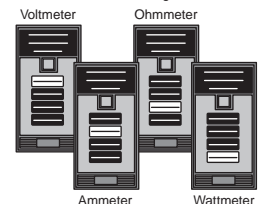

Voltmeter

Ohmmeter

Ammeter

Wattmeter

Includes EGA/VGA graphics, quick function key menu selection, and on-line help. Most importantly, Release 3.2 supports the advanced components available in Protoware™ circuit modules.

Protoware™ modules and diodes, transistor amplifiers and an electronic organ. A "cook-book" format makes it easy to learn and understand. Change component values and analyze the circuit. View the circuit in schematic or pictorial presentation. A great program for studying the basics of electronic circuits and test equipment.

IBM, trademark of International Business Machines, Inc.

\*Price includes 3 additional Protoware™ modules (diodes, transistors, and electronic organ)

510-PL-0006 \$24.95\*



**ADVANCED DIGITAL MULTIMETERS**

**Common Features:**

- AC/DC voltage: 750V / 1000V
- AC/DC current: 10A
- Resistance range: 20MΩ - 40MΩ
- Double insulated input jack
- Overload protection voltage up to max. 600V in resistance range, capacitance, continuity, and diode check
- 1000V between Com. and ground jacks
- 10A fused with input overload protection
- Introduction to surface mount technology (SMT)
- Designed to meet IEC-1010-1 safety requirements
- Wrong position protection
- Adopting unbroken tilt stand
- Diode test
- Continuity test
- Safety holster

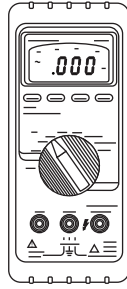

**3 1/2-Digit Display**

MOUSER STOCK NO.	Count	Range	Data Hold	TR hfe	Freq.	Capac.	Auto Off	Analog Bar Graph	Batt. Test	Price Each
585-DM311	2000	Man	No	No	No	No	No	No	Yes	50.99
585-DM312	2000	Man	No	Yes	Yes	Yes	No	No	No	79.99
585-DM313	2000	Auto/Man	Yes	No	No	No	No	No	No	59.99

**3 3/4-Digit Display**

MOUSER STOCK NO.	Count	Range	Data Hold	TR hfe	Freq.	Capac.	Auto Off	Analog Bar Graph	Batt. Test	Price Each
585-DM332	4000	Man	Yes	Yes	Yes	Yes	Yes	Yes	Yes	105.74
585-DM333	3200	Auto/Man	Yes	No	No	No	Yes	Yes	No	69.99
585-DM334	4000	Auto/Man	Yes	No	Yes	No	Yes	Yes	No	99.99

**DIGITAL CLAMP METER**

**Features:**

- 3 3/4-digit LCD display, 4000 count
- Meet UL, CSA, CE, and IEC-1010-1 safety standards
- Compact and rugged case
- Easy use with tear drop shape jaw
- Surge and overload protection in all range
- Data and peak hold functions
- Continuity check with beep sound



585-CM631D \$85.99

**DIGITAL MULTIMETER**

**Features:**

- 4 1/2-digit display, 5 digit green LED, 1999 count
- VDC basic accuracy of 0.05%
- Full overload protection
- Frequency measurement up to 200KHz
- Continuity check with beeper
- Data hold, diode check, TR hfe measurement available
- True RMS in AC range
- 600V overload protection in resistance range

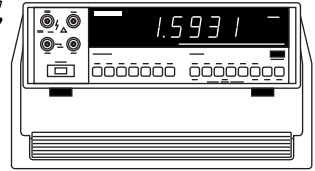

585-DM-441B \$229.99

**OSCILLOSCOPES**

The newest oscilloscopes from Goldstar offer economic choice for high quality. Suitable for use in schools, production, service, and maintenance of consumer products

**Common Features:**

- 6" rectangular CRT (8x10 DIV)
- Ch2 polarity inversion switch
- High-sensitivity X-Y operation
- Vertical gain sensitivity x5 magnifier
- Horizontal sweep time x10 magnifier
- Automatic focus
- Warranty: 2 years
- TV sync circuit
- Variable hold-off function
- Z-axis (intensity modulation)
- Level control for superior triggering
- Meets IEC-348 safety requirement
- 100V/120V/220V/240V, 50-60Hz, power source

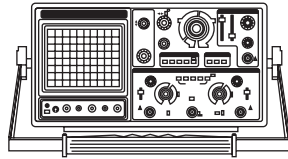

(User manual, 2 spare fuses, and probe set included)

MOUSER STOCK NO.	Freq. MHz	Trace	Channel	Signal Delay	Alt Trigger	RS232 Interface	Comp-act Size	Function Generator	Price Each
585-OS3020	20	Dual	2	No	No	Yes	No	---	1050.00
585-OS5020P	20	Dual	2	No	Yes	No	Yes	---	427.00
585-OS9020G	20	Dual	2	No	No	No	No	1MHz	559.99
585-OS9040D	40	Dual	2	No	No	No	No	---	776.00
585-OS9060D	60	Dual	2	No	No	No	No	---	921.00
585-OS8100A	100	8	3	No	No	No	No	---	1350.00
585-OS9100P	100	Dual	2	Yes	Yes	No	No	---	1022.77

**REGULATED DC POWER SUPPLY**

**Features:**

- Plastic case, considerably light
- Compact size, easy to carry
- Low power consumption
- Output polarity: positive and negative
- CC/CV indicator
- Built-in output current limit circuit
- Built-in 4 digit green LED for digital display (GP-4303D)
- Low ripple voltage less than 1.5mV-p-p
- Overload protection circuit

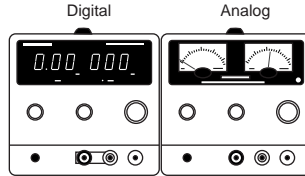

MOUSER STOCK NO.	Description	Price Each
585-GP4303A	Analog 30VDC 0-3A power supply	199.00
585-GP4303D	Digital 30VDC 0-3A power supply	229.00

**FREQUENCY COUNTERS**

**Features:**

- AC/DC coupling
- Attenuator (10:1)
- One year warranty
- Built-in CMOS gate array
- Fast, high-resolution, 8-digit green LED display
- Reciprocal technique for low frequency resolution
- Microprocessor controlled
- Total, RPM function, period
- INT/EXT time base selectable

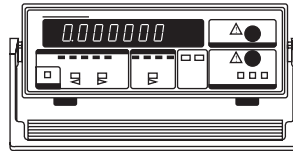

MOUSER STOCK NO.	Description	Price Each
585-FC-2015	150 MHz multi-function counter	269.00
585-FC-2130	1.3 GHz multi-function counter	309.99
585-FC-2015U	Universal 150MHz multi-function count.	309.00
585-FC-2130U	Universal 1.3GHz multi-function count.	369.00

**FUNCTION GENERATORS**

**Features:**

- DC offset control
- One year warranty
- Wide frequency range: 0.02Hz to 2MHz
- TTL/CMOS leveled square wave output
- Linear sweep control from 1:1 to 100:1
- Maximum attenuation of 40dB can be obtained
- Built-in 4-digit green LED display (FG-2002C only)
- Low distortion factor less than 1% at 10Hz to 100KHz
- Output impedance changeable: 50Ω or 600Ω (FG-2002C only)
- Variable symmetry to generate saw-tooth and pulse wave forms
- Versatile waveforms: sine, triangle, square, ramp and pulse, saw-tooth

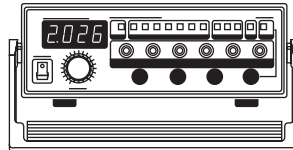

MOUSER STOCK NO.	Description	Price Each
585-FG-8002	2 MHz, sweep function generator	199.00
585-FG-2002C	2 MHz, sweep function generator with LED display	349.00

**OSCILLOSCOPE PROBE SET**

**Contents of Each Kit:**

- Probe w/ x1/x10 switch setting
- Band width: 100 MHz (x10); 10MHz (x1)
- 1 insulating tip
- 1 spring hook
- 1 trimmer tool
- 1 I.C. tip
- 1 BNC adaptor
- 1 ground lead
- 1 measuring tip

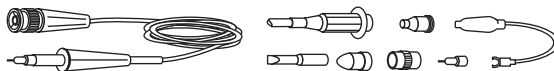

For quantities greater than listed, call for quote.

MOUSER STOCK NO.	Description	Price Each
585-OS-100A	2 probe kits, overall length is 59"	54.25



## DIGITAL STORAGE OSCILLOSCOPES

### Specifications:

- 20 MHz bandwidth
- 40 Ms/s sampling rate
- 2 channels
- Autoset
- 4 x 4 KB memory
- Cursors and readouts
- RS-232 interface standard
- IEEE-488 interface standard
- 50 ns glitch capture
- Up to 8,000 samples per waveform
- Dual time base
- Pre-trigger
- Triggers to 40 MHz
- Lab View® or Lab Windows® compatible
- IEC 1010 class 1 safety compliance
- 3-year warranty

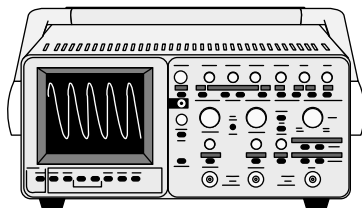

615-5020 Illustrated

**615-5020** **\$2219.00**

### Specifications:

- 100 MHz bandwidth
- 40 Ms/s sampling rate
- 2 channels
- Autoset
- 2 x 4 KB memory
- Cursors and readouts
- RS-232 interface standard
- No IEEE-488 interface
- 8 x 10 cm display
- 50 ns glitch capture
- Up to 4,000 samples per waveform
- Dual time base
- Pre-trigger
- Triggers to 180 MHz
- Lab View® or Lab Windows® compatible
- IEC 1010 class 1 safety compliance
- 3-year warranty

### Specifications:

- 100 MHz bandwidth
- 40 Ms/s sampling rate
- 2 channels
- Autoset
- 4 x 8 KB memory
- Cursors and readouts
- RS-232 interface standard
- IEEE-488 interface standard
- 8 x 10 cm display
- 50 ns glitch capture
- Up to 8,000 samples per waveform
- Dual time base
- Pre-trigger
- Triggers to 180 MHz
- Lab View® or Lab Windows® compatible
- IEC 1010 class 1 safety compliance
- 3-year warranty

**615-5100** **\$2495.00**

**615-5105** **\$2695.00**

## OSCILLOSCOPES

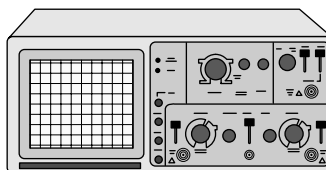

615-1541C Illustrated

### 40 MHz Dual-Channel

#### Specifications:

- 1 mV/div sensitivity
- 19 calibrated sweeps
- Video sync separators
- X10 sweep mag
- 3 year warranty

**615-1541C** **\$799.00**

### 20 MHz Dual-Trace

#### Specifications:

- 1 mV/div sensitivity
- Dual or single trace operation
- Calibrated 19 step time base with x 10 magnifier
- Compact low-profile design
- AUTO/NORM triggered sweep operation with AC, TVH, TVV, and line coupling
- 2 year warranty

**615-2120** **\$454.23**

### 100 MHz Three-Trace Dual Time Base

#### Specifications:

- 1mV/division sensitivity
- Sweeps to 5ns/division
- 22 calibrated ranges, main time base
- 19 calibrated ranges on delayed time base
- Signal delay line
- Channel 1 output
- Trigger view channel, CH 3
- 15 kV accelerating voltage

**615-2190** **\$1599.00**

### 60 MHz Dual-Trace

#### Specifications:

- 1 mV/div sensitivity
- Sweep to 5 ns/div
- 23 calibrated ranges - main time base
- 19 calibrated ranges - delayed time base
- Signal delay line
- Component tester
- V mode-displays two signals unrelated in frequency
- Z axis input
- Single sweep
- Beam finder
- UNCAL indicators
- 3 year warranty

**615-2160** **\$1099.00**

## DC POWER SUPPLIES

B&K-PRECISION power supplies provide the versatility and reliability required for a broad spectrum of laboratory and service applications. They are ideal for use in engineering, industrial service shop, lab and school applications. Each power supply is built for continued stability and accuracy over a wide range of operating conditions.

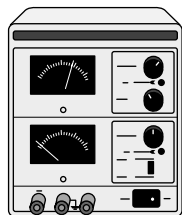

Single Output  
615-1735 Illustrated

### Single Output

#### Features:

- Output voltage: 0-30V
- Output current: 0-1A
- Constant voltage/constant current operation
- 2 analog
- 2 year warranty

**615-1710** **\$229.00**

#### Features:

- Output voltage: 0-60V
- Output current: 0-2A
- Constant voltage/constant current operation
- 2 analog
- 2 year warranty

**615-1711** **\$309.00**

#### Features:

- Output voltage: 0-30V
- Output current: 0-3A
- Constant voltage/constant current operation
- 2 analog
- Operate continuously at full load without overheating
- Coarse and fine voltage controls
- 2 year warranty

**615-1730** **\$315.00**

#### Features:

- Output voltage: 0-30V
- Output current: 0-3A
- Constant voltage/constant current operation
- Continuously monitor voltage and current output on two meters
- 2 digital
- 2 year warranty

**615-1735** **\$380.00**

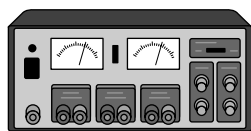

Triple Output  
615-1760 Illustrated

### Triple Output

#### Features:

- Two 0-30VDC, 2A sections capable of independent, series or parallel operation
- One 4-6.5VDC, 5A section
- Switchable series/parallel operation 30V sections
- Adjustable current limit controls 30V sections
- Two 3 digit LED displays - one reads volts or amps of "B" supply - one reads volts or amps of "A" supply or 4V-6.5V supply
- Unique variable tracking, B track A at 5% to 100%

**615-1760** **\$649.00**

### Compact Triple Output

- Two 0 to 24VDC outputs (0.5A)
- One fixed 5V output (4A)
- Independent or tracking operation
- Adjustable current limiting
- Designed to operate continuously at rated output
- Overload protection: short circuit, overvoltage, and reverse polarity
- Connect outputs in series for higher voltage output or in parallel for higher current output (switch selectable)
- 1 year warranty

**615-1651** **\$429.00**

- Output voltage: 0-30V @ 2.5A; 12V and 5V @ 0.5A
- All features of Model 1651

**615-1670** **\$199.00**

### High Current

- 3 to 14 volts DC output
- 12 amps guaranteed, 12 amps typical @ 13.8V
- Overload protection: short circuit, overvoltage, and reverse polarity
- Thermostatically controlled cooling fan
- 1 year warranty

**615-1686** **\$199.00**

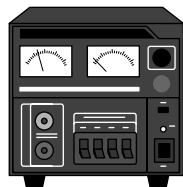

High Current  
615-1686 Illustrated

## FUNCTION GENERATORS

615-4011 Illustrated

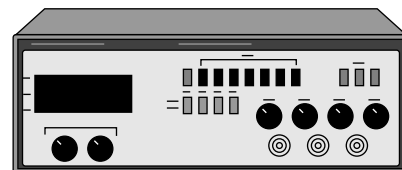

B&K-PRECISION offers a full-range of function generators so you can choose the generator best suited to your own activities or applications. The line consists of a variety of high performance generators including function, sweep/function, RF and audio. All are rugged lab-grade instruments capable of satisfying a variety of engineering, testing, and service situations. Each has been engineered for high-reliability and user operating convenience.

### Sine/Square Wave Audio Generator

#### Features:

- 20Hz to 150kHz in 46 steps
- Low distortion R-C oscillator
- Variable output control
- Low battery indicator

**615-3001** **\$79.00**

### 5 MHz Function Generator with Digital Display

#### Features:

- 0.5Hz to 5MHz
- Sine, square, triangle, pulse, and ramp output
- Coarse and fine tuning
- 4 digit LED display
- Variable duty cycle
- Variable DC offset

**615-4011** **\$284.00**

### 2 MHz Function Generator

#### Features:

- 0.2Hz to 2MHz in 7 ranges
- Sine, square, triangle, pulse, and ramp output
- Variable duty cycle
- Variable DC offset

**615-4010** **\$229.00**

### 10 MHz Sweep/Function Generator with Digital Display

#### Features:

- 0.1Hz to 10MHz
- Linear and log sweep
- 5 digit LED display
- All features of Model 4011

**615-4017** **\$369.00**

### 20 MHz Sweep/Function Generator with Frequency Counter

#### Specifications:

- 0.2Hz to 20MHz
- AM and FM modulation
- Burst operation
- External frequency counter to 30MHz
- 5 digit LED display
- All features of Model 4017

**615-4040** **\$499.00**

## ACCESSORIES

MOUSER STOCK NO.	Manufacturer Part Number	Description	Price Each
615-2001	TL-1	Standard test leads	8.00
615-2002	TL-2	Deluxe test lead set	20.00
615-2003	TL-3	Accessory tip kit	12.00
615-2100	DP-21	Digital logic probe	34.00
615-2103	CP-3	DC/AC current clamp adaptor	86.00
615-2129	LC-29A	DMM case	10.00
615-2144	HV-44	High-voltage probe/meter 0-40,000V	109.00
615-23701	PR-37AG	Oscilloscope probe gray	54.50
615-23702	PR-37AR	Oscilloscope probe red	54.50

**DIGITAL MULTIMETERS**

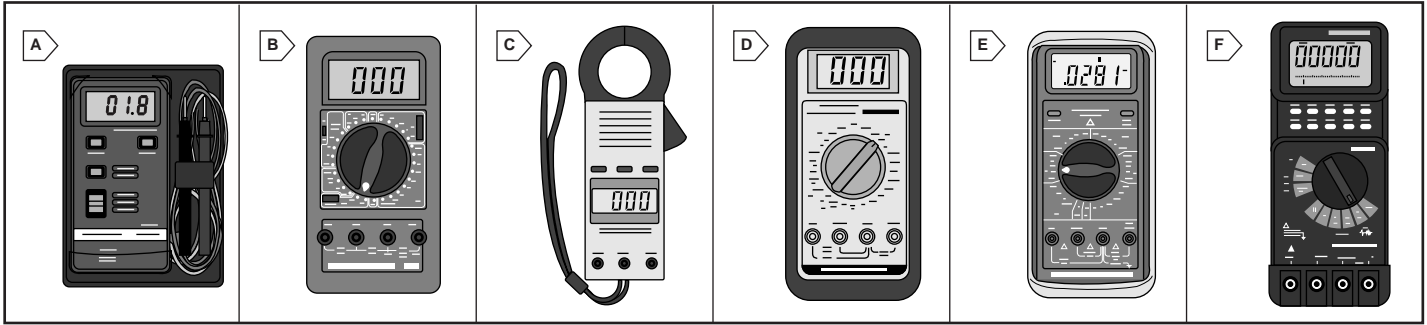

MOUSER STOCK NO.	Fig.	DCV ACC	Ranging	Display LCD	Analog Bar Graph	Data Hold	Memory	Cap	Frequency	Logic	Tran Gain	Temp.	Auto Off	Warranty	Price Each
615-2700	A	1.3	Auto	3200	Yes	Yes	No	No	No	No	No	No	Yes	1 Year	33.00
615-2703A	B	0.5	Manual	3 1/2	No	No	No	No	No	No	No	No	No	1 Year	39.00
615-2704A	B	0.5	Manual	3 1/2	No	No	No	Yes	No	No	No	No	No	1 Year	59.99
615-2706	B	0.5	Manual	3 1/2	No	No	No	Yes	No	No	Yes	Yes	No	1 Year	79.00
615-2707	B	0.5	Manual	3 1/2	No	No	No	Yes	Yes	Yes	Yes	No	No	1 Year	89.00
615-330	C	1.0	Manual	3 1/2	No	No	No	No	No	No	No	No	Yes	1 Year	89.00
615-2860A	D	0.5	Manual	3 1/2	No	No	No	No	No	No	No	No	Yes	5 Years	99.00
615-388A	E	0.5	Manual	4000	No	No	No	Yes	Yes	Yes	Yes	No	Yes	3 Years	119.00
615-389	E	.25	Auto	4000	Yes	Yes	Yes	Yes	Yes	No	No	No	Yes	3 Years	139.00
615-390	E	0.1	Auto	4000	Yes	Yes	Yes	Yes	Yes	No	No	Yes	Yes	3 Years	159.00
615-391	E	.05	Manual	4 1/2	No	Yes	No	No	Yes	Yes	No	No	Yes	3 Years	179.00
615-5370	F	.05	Auto	4 1/2	Yes	No	Yes	Yes	Yes	No	No	Yes	No	3 Years	289.00

**PREMIUM DIGITAL MULTIMETER**

**Display Features:**

- 50,000 count resolution
- Autoranging or manual ranging
- 34 segment analog bargraph
- Fast 20 times/second bargraph
- Visual annunciators for function and unit of measurements
- Power disturbance indicator
- Bargraph zoom, X5 magnification equivalent 170 segment resolution
- Readouts for bargraph range in zoom
- Power disturbance indicator: displayed when presence of Transient or Harmonics occur on AC voltage being measured

- Backlit LCD
- Low battery indicator
- Blown fuse indicator
- Identifies which fuse
- Live circuit indicator

**Accuracy Specifications:**

- DC volts: 0.05%
- DC mA: 0.05%
- AC volts: 0.3%
- AC mA: 0.6%
- Ohms: 0.07%
- Frequency: 0.03%
- Capacitance: 1.0%
- dBm: 0.03dB
- Duty Cycle: 0.03%
- Temperature: 0.5°C

**Special Features:**

- RS-232 capability built in
- Record readings printer/computer
- Selectable record internal
- Recalibrate via RS-232 without opening case
- Record calibration data
- Data hold
- Auto hold upon probe touch and stabilize
- 1ms peak hold
- Peak hold + (surge) or Peak hold - (sag)
- Relative mode
- Settable reference value in relative mode
- Min/Max/Avg record
- 500 hour battery life

- Auto power off conserves battery
- Auto power override in Min/Max record, peak hold, event counting RS-232 or live circuit conditions
- True RMS, crest factor 6
- Selectable 10MΩ or 1GΩ input impedance on 500mV range
- Sealed case, keeps out dust and contaminants
- Water tight, IP677 compliant
- Shock and vibration resistant MIL-T-26800
- Extended operating temperature
- 3 year warranty



615-5370 \$289.00

**ANALOG MULTIMETER**

**Features:**

- 20,000Ω/volt DC
- 28 ranges
- 3 1/2" mirrored scale
- Tests batteries under load
- Tests transistors
- Includes batteries and test leads



**Specifications:**

- Accuracy specifications apply from +18°C to +28°C

615-114A \$42.00

**POCKET SIZED MULTIMETER**

**Features:**

- Compact size (1 3/16 x 2 3/8 x 3 1/2)
- Measures AC & DC voltage and DC current
- One 1.5V, AA size battery (included)
- Test leads and instruction manual included

**Specifications:**

- Measures resistance R x 1KΩ ±4° arc of scale length
- Measures decibels -20dB to +56 dB on AC voltage ranges
- 0-10, 50, 250, 500V scales ±4% accuracy
- 2,000 Ω/V sensitivity
- 0-0.5, 50, 250 mA scales ±4% accuracy



615-117 \$13.00

**AUTO RANGING CAPACITANCE METER**

**Features:**

- 3 1/2 digit LCD display
- Measures capacitance to 199.9 mF
- 10 ranges from 199.9 pF to 100.0 mF



615-830 \$339.00

**DUAL-DISPLAY HAND-HELD LCR BRIDGE WITH STATISTICAL FUNCTIONS**

**Features:**

- Measures capacitance, resistance, and inductance
- Measures dissipation factor of capacitors and Q of inductors
- Simultaneously displays measured value and Q or dissipation factor
- Tolerance mode "beeps" to indicate measured components outside a 1%, 5%, or 10% tolerance around a reference value
- Two selectable test frequencies (120Hz, 1kHz)
- Auto or manual ranging



615-878 \$275.00

**LCR METER**

**Features:**

- Measures capacitance, resistance, and inductance
- Measures dissipation factor of capacitor and 1/Q of inductors
- 3 1/2 digit LCD display



615-875A \$199.00

**HAND-HELD PARTS TESTER**

**Features:**

- Large 0.8" digit, high contrast LCD readout
- 25 user ranges for versatile test selection
- Tests resistance from 0.1Ω through 20MΩ
- Tests transistors, SCRs, diodes, and LEDs
- Tests batteries under actual loaded conditions
- 5 foot drop-proof, heavy duty case
- Tilt stand for benchtop use

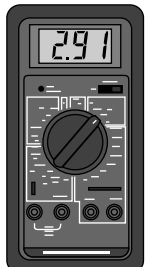

615-815 \$99.00



## XL POCKET SERIES FULL-FUNCTION COMPACT DMM

- More compact
- Full-function, full-performance

**569-DM2** **\$29.95**

- Large LCD Digits
- Safety test leads
- Input warning beeper

**569-DM5XL** **\$39.95**

- Large LCD Digits
- Safety test leads
- Input warning beeper
- Safety Tester™ feature: detects and display the presence of particular AC or DC voltage levels through a series of LEDs

**569-DM10XL** **\$49.95**

- Large LCD Digits
- Safety test leads
- Input warning beeper
- Logic tester feature: detects and displays the presence of TTL pulses up to 20MHz

**569-DM15XL** **\$59.95**

- Test leads
- Non-shrouded 90° banana plugs
- 30" PVC insulated (1 red, 1 black)

**569-TL25** **\$5.00**

### Common Features:

- Large 3 1/2 digit display
- Input warning beeper
- Safety test leads
- DC voltage range: 200mV, 2V, 20V, 200V, 1000V
- DC current range: 200µA, 2mA, 20mA, 200mA
- Resistance range: 200Ω, 2KΩ, 20KΩ, 200KΩ, 2MΩ
- Diode test: 3.2VDC/1mA

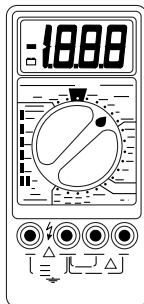

DM10XL illustrated

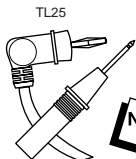

**NEW IN '97**

## XT SERIES HIGH-PERFORMING, FULL-FUNCTION DMM

- Detects live AC voltages without using the DMM battery. A bank of four LEDs indicates an AC voltage presence up to 440V.
- Measures and displays temperature in either Celsius or Fahrenheit degrees

**569-DM23XT** **\$89.95**

- Measures signal frequencies up to 2KHz
- Capacitance measurement capability from 2nF up to 2000µF

**569-DM25XT** **\$99.95**

- Measures capacitance from 2nF to 2000µF
- Measures inductance from 1µH to 20H
- Measures signal frequencies up to 20MHz
- Autoranging when measuring frequency, automatically adjusting to display the appropriate frequency unit

**569-DM27XT** **\$119.95**

- Measures capacitance from 2nF to 20mF
- Frequency accuracy is ±0.5% +3/0.1Hz
- Temperature range: -30°C to 1300°C  
-22°F to 2000°F

**569-DM28XT** **\$119.95**

- Test leads
- Shrouded 90° banana plugs
- 40" PVC insulated lead wire, insulated probe tips (1 red, 1 black)

**569-TL30** **\$11.00**

- Test leads
- Shrouded 90° banana plugs
- 36" PVC insulated, (1 red, 1 black)

**569-TL245** **\$10.00**

### Common Features:

- Large 3 1/2 digit display
- Input warning beeper
- 10A fused AC/DC current
- Logic test
- DC voltage range: 200mV, 2V, 20V, 200V, 1000V
- AC voltage range: 200mV, 2V, 20V, 200V, 750V
- AC/DC current range: 200µ, 2m, 20m, 200m, 10A
- Resistance range: 200Ω, 2KΩ, 20KΩ, 200KΩ, 2MΩ, 20MΩ, 200MΩ
- Continuity test: beeper <75Ω

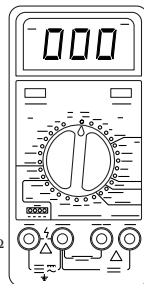

DM25XT illustrated

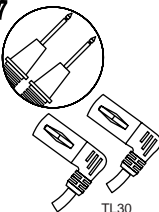

**NEW IN '97**

TL245

## 4-DIGIT, ANALOG AND DIGITAL DISPLAY TRUE RMS DMM

### Features:

- Probe Hold™
- Auto Min Max™ (auto ranging)
- Auto Rel™ (auto ranging)
- Overload Alert™

### Specifications:

- DC voltage: 1V, 10V, 100V, 1000V
- AC 45Hz to 10KHz: 10V, 100V, 750V
- AC/DC current: 10mA, 40mA, 10A
- Diode test: 2.25V @ 4.5mA
- Resistance: 1K, 10K, 100K 1M, 10M, 40MΩ



**569-RMS225** **\$189.95**

## 4-DIGIT, ANALOG AND DIGITAL DISPLAY, HEAVY DUTY TRUE RMS DMM

### Features:

- Drop and contamination proof
- Auto Min Max™ (autoranging)
- 20A AC/DC current ranges
- Probe Hold™
- High energy, 10KV transient protection
- Durable electrical test lead set

### Specifications:

- Operating temperature: -20° to +55°C
- DC voltage: 1V, 10V, 100V, 1000V
- AC 45Hz to 10KHz: 10V, 100V, 1000V
- AC/DC current: 10mA, 40mA, 10A, 20A
- Diode test: 2.25V @ 4.5mA
- Resistance range: 1K, 10K, 100K 1M, 10M, 40MΩ



**569-HD160** **\$219.95**

## 3 1/2-DIGIT, HEAVY DUTY DMM

Designed for dependability under rugged industrial conditions. Built of tough, fire-retardant thermoplastic, with all sensitive components shock-mounted. Waterproof construction prevents dirt, grime, and moisture from entering the case and causing inaccurate readings or damaging shorts.

### Features:

- Completely sealed and environment proof meters
- VDC accuracies of 0.07 to 0.1%
- New continuity test with continuous tone
- Average sensing and true RMS models
- Temperature input

**NEW IN '97**

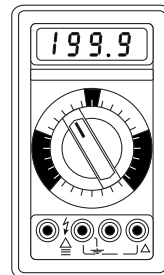

**569-HD110T** **\$239.95**

## 4-DIGIT, ANALOG AND DIGITAL DISPLAY TRUE RMS DMM

### Features:

- (AC, AC+DC) reading
- 2MHz frequency counter
- Capacitance meter to 2000µF
- 0.01Ω resolution
- Intermittent detector
- Probe Hold™
- Auto Min Max™ (autoranging)
- 50ns pulse detector
- Peak hold
- Fiberoptic backlight

### Specifications:

- AC/DC voltage: 100mV, 1000mV, 10V, 100V, 1000V
- AC frequency: 45Hz to 400Hz; 3dB > 10KHz
- AC/DC current: 1000µA, 10mA, 100mA, 1000mA, 10A, 20A
- Resistance: 100Ω, 1000Ω, 10KΩ, 100KΩ, 1000KΩ, 10MΩ, 20MΩ
- Capacitance ranges: 20nF, 200nF, 2µF, 20µF, 200µF, 2mF

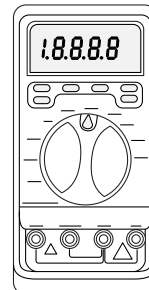

**569-2030** **\$299.95**

## 4-DIGIT, ANALOG AND DIGITAL DISPLAY DMM

### Features:

- Large LCD with .78" high digits
- Shrouded test leads, incorrect input jack warning, fully fused current input jacks
- High resolution: 4000 count, 42 segment bargraph
- Protective rubber boot with tilt stand and flex-strap
- Wavetek's exclusive "No Hassle" warranty

### Specifications:

- AC/DC voltage: 400mV, 4V, 40V, 1000VDC/750AC
- AC/DC current: 4mA, 40mA, 400mA, 20A
- Resistance: 400, 4K, 40k, 400K, 4M, 40MΩ
- Capacitance ranges: 4nF, 40nF, 400nF, 4µF, 40µF

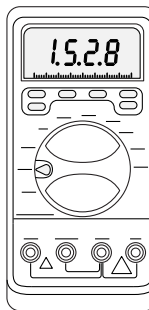

MOUSER STOCK NO.	AC Conversion	Price Each
569-2005	True RMS, AC coupled	159.95
569-2015	Average sensing, RMS indicating	179.95

## PEN-TYPE DMM

### Features:

- Autoranging
- 4200 count resolution
- Probe Hold™
- Continuity test with beeper
- Measures to 300VAC, 500VDC, or to 2MΩ
- Warranty: one year

### Specifications:

- DC voltage: 300V
- AC voltage: 300V
- Resistance ranges: 420Ω, 4.2KΩ, 42KΩ, 420KΩ, 4.2MΩ

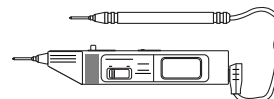

**569-DM73A** **\$69.95**

## 3 1/2-DIGIT DISPLAY COMPONENT TESTER

This component testing instrument is an ideal complement to the Wavetek line of digital multimeters. A hand-held meter that is battery-operated and equipped with test leads.

### Features:

- Inductance, capacitance, and resistance meter with dissipation

**NEW IN '97**

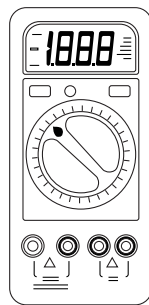

**569-LCR55** **\$179.95**

## LOGIC PROBES

- Detects logic levels as narrow as 30ns @ up to 17MHz
- Switch selectable TTL or CMOS
- Signal input protected ±220VAC/DC for 15 seconds
- Input impedance 1MΩ
- Pulse memory

- Measures TTL, DTL, RTL, CMOS, NMOS, & MOS
- Detects logic levels as narrow as 30ns @ up to 25MHz

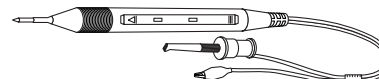

**569-LP10A** **\$19.95**

**569-LP25A** **\$39.95**



# Test Equipment, Tool Cases, and Vacuum

## Simpson 260 (SERIES 8) VOMS

### Features:

- Excellent nulling and peaking
- Large color coded scales
- AC frequency response to 100KHz
- Varistor protected meter movement
- Zero RFI
- Mirrored scale parallax reduction
- Standard and high energy overload fusing
- Includes test leads and batteries
- Audible continuity check 260-8P resettable over load circuit
- Protection relay 260-8P only



### Specifications:

- Measures to: 1000VDC, 1000VAC, 10A AC/DC, X10K resistance
- Dimensions: 7" H x 5.5" W x 3.1" D
- Overload protection: (1) 1A, 250V fuse and (1) 2A/600V fuse
- Weight: 3 Lbs.

MOUSER STOCK NO.	Description	Price Each	
		1	2
529-260-8	Analog VOM-black	187.50	178.13
529-260-8P	Analog VOM-black w/resettable overload protection	250.00	237.50
529-00805	Carrying case (not illustrated)	63.25	60.09
529-00043	Test leads with screw-on clips (not illustrated)	15.30	14.54

## GREENLEE® WIRE SORTER KIT

- Sorts up to 10 wires at a time
- Max. distance: up to 3 miles
- Ideal for one-man sorting
- Simplifies cable identification
- Indicates opens and shorts
- Portable 2-piece digital readout system
- Complete with padded carrying case, leads, and 9V battery
- Size: 14" x 11" x 3"

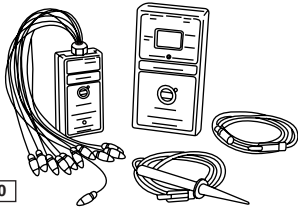

586-5775VS \$ 376.00

## GREENLEE® POWER FINDER))) CIRCUIT TRACER

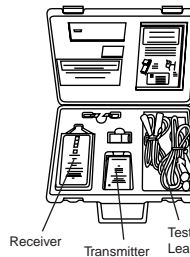

Locate and identify circuits, fuses, breakers, and wiring, even inside conduits or underground. Plug the transmitter into an outlet (≤300V) and trace the path with the hand held receiver.

### Specifications:

- Transmitter:**
  - Operating voltage: 9-300V @ 8mA
  - Size: 2.75" x 2" x 1.5"
- Receiver:**
  - Power: 9V battery (included)
  - Size: 5.5" x 2.75" x 1"

586-2007 \$ 345.00

## GREENLEE® VOLTAGE AND CONTINUITY TESTER

### Features:

- AC/DC switchless, dial free
- Automatic range selection
- Test resistance up to 300KΩ
- Triple-insulated cord
- 1 probe identifies hot side with light and buzzer (no ground needed) during continuity testing not damaged if accidental contact with voltage
- Indicator lights up for 6, 12, 24, 50, 115, 240, and 440V AC/DC
- Size: 8" x 2" x 1.25"

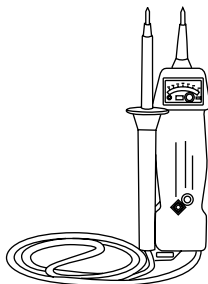

586-6708 \$ 84.50

## GREENLEE® VOLTAGE INDICATOR

### Features:

- Senses presence of AC voltage without contact
- Audible and visual indicators
- Pocket clip acts as on/off switch

### Specifications:

- Capacity: 50-500 VAC
- Power source: (2) No. 357 calculator or watch batteries (included)
- Size: 5 1/4" long
- Weight: 1 lb.

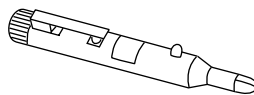

586-35952 \$ 19.00

## GREENLEE® SUBMERSIBLE POCKET LIGHT

### Features:

- Dimension: 4.75" x .625"
- Watertight to 500 feet
- Focused beam (Xenon lamp module)
- 400% brighter than ordinary pocket lights
- 2 AAA batteries included
- Made in USA
- Lifetime guarantee
- Color: yellow



MOUSER STOCK NO.	Description	Price Each
586-46500	Pocket flashlight	12.00
586-46534	Replacement O-ring	.25
586-46533	Replacement Xenon lamp	5.70

## platt TOOL CASES

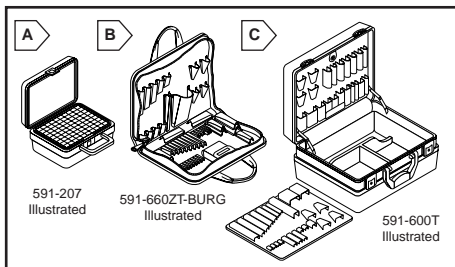

### Mini Tech

Black cordura. 14 interior sewn tool pockets and one pouch.

MOUSER STOCK NO.	Fig.	Dimensions (In.)	Price Each
591-601ZT	B	10 x 7 x 2	47.00

### Trouble Shooter

Burgandy cordura with two exterior meter pockets and one document pocket. Interior has 29 sewn tool pockets and one meter pouch.

591-660ZT-BURG	B	12.5 x 9.5 x 2	86.00
----------------	---	----------------	-------

### Master Technician

Burgandy cordura with three exterior pockets. Interior has 47 sewn tool pockets and one meter pouch. Shoulder strap included.

591-669ZT-BURG	B	15 x 11 x 2	122.00
----------------	---	-------------	--------

### Combo Tool and Attache Case

47 sewn tool pockets made of Neoluxe for durability. Attache side has pockets for files, manuals, etc. plus built in clipboard. Cordura nylon exterior with industrial zippers. Shoulder strap included.

591-679ZT	C	17 x 10 x 6	158.00
-----------	---	-------------	--------

### Standard Polyethylene

Black HMW polyethylene exterior with durable molded ribbed shell. Extruded aluminum frame with cast key locks and molded handle. Interior body divider, literature pocket, and two molded pallets.

591-600T	C	18 x 13 x 6	156.00
----------	---	-------------	--------

### Deluxe Polypropylene

Black, chemical resistant finish, with extruded aluminum frame, golf grip handle, cast chrome key locks, and full length piano hinge. Interior has two molded pallets, bottom divider and deluxe literature pocket.

MOUSER STOCK NO.	Fig.	Dimensions (In.)	Price Each
591-800T	C	18 x 13 x 6	174.00

### Deluxe Polyethylene

Black, chemical resistant, with contemporary molded rib shell. Heavy-duty, satin anodized aluminum frame with gasket, and full length piano hinge, cast key locks, and golf grip handle. Interior has two molded pallets, body divider and deluxe literature pocket.

MOUSER STOCK NO.	Fig.	Dimensions (In.)	Price Each
591-906T	C	18 x 13 x 7	193.00

### Heavy Duty Polyethylene

The exterior shell is tough impact resistant HMW polyethylene. Heavy duty aluminum rim with black trim and gasket, golf grip handle, cast chrome key locks, and full length piano hinge.

3-piece foam interior with pre-cut cubed foam layer over bottom cushion and convoluted foam in lid.

- Includes telescoping handle and wheels.

MOUSER STOCK NO.	Fig.	Inside Dimensions (In.)	Body Depth (In.)	Price Each
591-221609H	C	22 x 16 x 9	5	264.00

### Blow Molded Cases

High-density polyethylene cases with double wall construction. Textured exteriors resist dents, cracking, and scuffs. Unaffected by extreme temperatures. The interiors utilize pre-cut cubed foam in the bodies and egg crate or foam pad in the lids. (See Figure A)

MOUSER STOCK NO.	Dimensions (In.)		Price Each
	O.D.	I.D.	
591-207	10.5 x 7 x 3	9.5 x 6 x 2.625	17.00
591-407	13.5 x 10 x 5.5	12.5 x 9 x 5.125	33.50
591-707	19 x 14 x 7.125	17.75x12.75x6.625	79.00

## 3M ELECTRONICS VACUUM

A powerful unit for high efficiency clean up of most business equipment.

### Features:

- 1 HP motor
- Stretch hose extends from 2" to 10"
- Comes complete with wand, crevice tool, crevice brush, dusting brush, needle nozzle, and Type 2 filter
- Attachments and power cord store inside door of high impact plastic case
- 3 year warranty

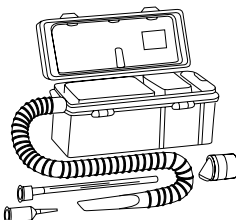

### Replacement filters:

- Type 1** small particle: traps extremely fine particles in the range of .3-.5 microns from highly sensitive equipment.
- Type 2** medium particle: traps toner and dust from copiers, laser printers, and other office equipment.

MOUSER STOCK NO.	Description	Price Each	
		1	5
517-497AJM	Electronics vacuum	214.00	204.00
517-SF1	Type 1 filter	30.28	---
517-MF2	Type 2 filter	14.61	---
517-CS1	Optional carrying strap	7.61	7.35

NEW THIS ISSUE NEW THIS ISSUE NEW THIS ISSUE NEW THIS ISSUE NEW THIS ISSUE

## SUPER SERIES SURGE SUPPRESSORS

### Features:

- Effective and economical surge suppressors
- Models with up to 8 outlets
- Plus Tel and FM models feature RJ11 jacks to protect phone/modem/fax lines, Super 7 Coax features coax jacks for video protection
- Up to 96,000 amps of surge suppression with up to 1,200 joules
- Up to \$15,000 Ultimate Lifetime Insurance

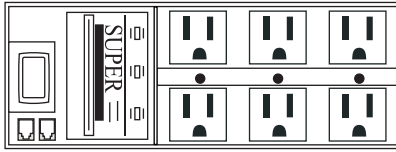

MOUSER STOCK NO.	Outlets	Description	Ultimate Coverage	Price Each	
				1	2
545-MP	1	Spike / Noise protection for 1 data-line, direct plug in	2 year	15.95	14.93
545-STIK	6	6 ft. power cord	Lifetime	21.21	19.28
545-STRIKER	6	4 ft. power cord, super 6	Lifetime	17.95	17.05
545-S7	7	7 ft. power cord, LEDs	\$5,000	23.77	22.49
545-S7TEL	6	7 ft. power cord, modem/fax	\$5,000	24.11	23.05
545-S7COAX	6	7 ft. power cord, coax jacks, LEDs	\$5,000	33.95	31.30
545-SK6-6	8	8 ft. power cord, LEDs	\$10,000	38.21	34.43
545-S8TEL	7	8 ft. power cord, modem/fax	\$10,000	50.96	47.88
545-SK6-0	6	Direct plug-in model	2 year	23.70	21.38
545-TSB	1	3 stage modem / fax line protection	2 year	49.95	46.66
545-TR6	6	6 ft. power cord, LEDs	\$15,000	53.95	45.36
545-TR6FM	6	6 ft. power cord, modem/fax	\$15,000	45.68	41.58

## ISOBAR® ULTRA PREMIUM SURGE SUPPRESSORS

### Features:

- Superior surge, spike and RFI/EMI line noise protection
- Diagnostic LEDs alert you to power problems before damage can occur
- Instantaneous surge response
- Virtually-indestructible all-metal housing
- Suppresses up to 120,000 amp spikes, up to 1,500 joules
- Isotel models feature dual RJ11 jacks for complete modem/fax surge suppression
- \$25,000 Ultimate Lifetime Insurance

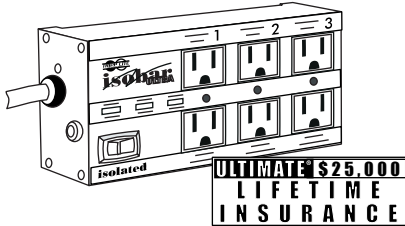

MOUSER STOCK NO.	Outlets	Description	Price Each	
			1	2
545-SS008	4	6 ft. power cord, 2 filter banks, LEDs	80.95	73.11
545-SS009	6	6 ft. power cord, 3 filter banks, LEDs	94.45	83.37
545-SS010	8	12 ft. power cord, 4 filter banks, LEDs	105.25	95.25
545-SS012	2	Direct plug in, 2RJ11 Jacks, Isobar ultrafax	59.95	55.08
545-SS013	6	6 ft. power cord, 3 filter banks, modem/fax LEDs, Isotel 6 ultra	107.96	98.33
545-ISTL8MULT	8	12 ft. power cord, 4 filter banks, modem/fax LEDs, Isotel 8 multimedia	121.46	110.30

## ISOBAR® PREMIUM SURGE SUPPRESSORS

### Features:

- Superior surge, spike and RFI/EMI line noise protection
- Instantaneous surge response
- Virtually-indestructible all-metal housing
- Suppresses up to 120,000 amps up to 1,350 joules
- Exclusive Isotel filter banks eliminate interference between connected equipment
- Up to \$25,000 Ultimate Lifetime Insurance

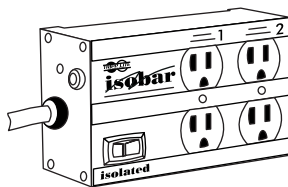

MOUSER STOCK NO.	Outlets	Description	Ultimate Coverage	Price Each	
				1	2
545-SS001	2	Direct plug-in Isobar	\$10,000	43.20	35.83
545-SS002	2	6 ft. power cord	\$10,000	53.96	49.25
545-SS003	4	6 ft. power cord, 2 filter banks	\$25,000	69.76	66.27
545-SS004	6	6 ft. power cord, Isobar 6	\$10,000	79.00	71.15
545-SS007	6	6 ft. power cord, 3 filter banks	\$25,000	62.95	58.14
545-IBAR8RM	8	12 ft. power cord, 4 filter banks remote on/off switch	\$10,000	100.26	95.25
545-IBAR12	12	12 ft. power cord, rackmount Isobar	\$10,000	134.10	128.16
545-SS011	4	6 ft. power cord, 2 filter banks, modem/fax	\$25,000	89.95	82.94

## LAPTOP COMPUTER SURGE SUPPRESSOR

### Features:

- Protects your laptop's AC and modem/fax lines to eliminate all surge pathways
- Modem/fax and telephone jacks make simultaneous connection of all communication devices possible
- RFI/EMI line-noise filtering improves connection quality and speeds
- LED indicates that all protection circuitry is working
- \$5,000 Ultimate Lifetime Insurance covers the SMP and all connected equipment against surge damage - including direct lightning strikes

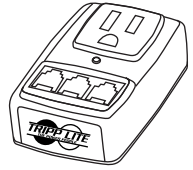

MOUSER STOCK NO.	Outlets	Description	Ultimate Coverage	Price Each	
				1	2
545-SMP	1	450 joule rating	\$5,000	25.08	22.80

## LAPTOP POWER SUPPLY

### Features:

- Plugs into your car's cigarette lighter, converting your car's battery power into clean, safe, household AC
- Ideal for laptop computers, fax machines, cellular phones, and other small electronic equipment
- Supplies 125 watts of continuous household AC power

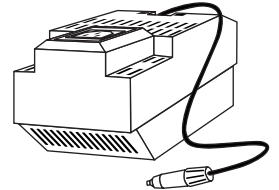

MOUSER STOCK NO.	Outlets	Description	Price Each	
			1	2
545-PV125	1	Supplies 125 watts of continuous AC power	80.00	75.00

## LINE CONDITIONERS

### Features:

- Multiple levels of voltage correction automatically adjust incoming power, converting it to acceptable, safe levels
- Keep electronic equipment working through brownouts and overvoltages
- Built-in surge, spike and line noise suppression
- Diagnostic LEDs show line integrity and voltage levels
- Up to \$25,000 Ultimate Lifetime Insurance



MOUSER STOCK NO.	Outlets	Description	Price Each	
			1	2
545-LS600	2	600 watts, low-voltage regulation only		92.75
545-LS604	4	600 watts, low/high voltage regulation		139.00
545-LC1200	4	1200 watts, Isobar protection		217.55
545-LC1800	6	1800 watts, Isobar protection		284.05
545-LC2400	6	2400 watts, Isobar protection		369.00
545-LCR2400	14	2400 watts, Isobar protection		409.00

## POWER VERTER INVERTERS

### Features:

- Convenient, portable AC power
- Solid-state power inverters convert 12VDC battery power into 120VAC (60Hz)
- PowerVerter models economically operate most household appliances
- PowerVerter Plus (FC) models provide up to 200% of their rated output to power heavy start-up loads and are frequency-controlled to work with sensitive equipment

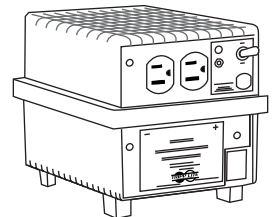

MOUSER STOCK NO.	Outlets	Description	Price Each	
			1	2
545-PV200	1	200 watts	109.00	99.00
545-PV400	1	400 watts	159.00	149.00
545-PV400FC	2	400 watts	233.56	230.00
545-PV550	2	550 watts	229.00	219.00
545-PV750FC	2	750 watts	389.00	359.00
545-PV1200FC	2	1200 watts	599.00	549.00

NEW THIS ISSUE NEW THIS ISSUE NEW THIS ISSUE NEW THIS ISSUE NEW THIS ISSUE

NEW THIS ISSUE NEW THIS ISSUE NEW THIS ISSUE NEW THIS ISSUE NEW THIS ISSUE

## BC PERSONAL AND BC INTERNET UPS SYSTEMS

### Features:

- Complete protection against blackouts, brownouts, surges, spikes, and EMI/RFI line noise
- Smallest footprint, ultra-compact design
- Diagnostic LEDs alert you to UPS operating conditions
- Internet models feature RJ11 jacks for superior surge, spike, EMI/RFI protection on your internet connection
- \$25,000 Ultimate Lifetime Insurance for connected equipment

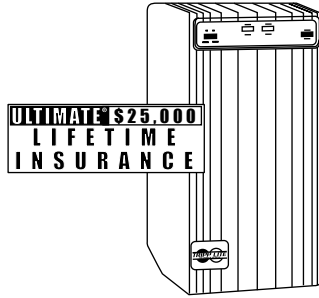

MOUSER STOCK NO.	Outlets	Output VA	Backup Time 1/2 Load (min.)	Weight (lbs)	Price Each	
					1	2
545-200	2	200	28	11	103.55	97.47
545-280	2	280	17	12	122.50	111.72
545-BCINT280	2	280	15	12	130.15	127.55
545-420	4	420	17	14.5	166.25	158.27
545-500	4	500	28	19	217.55	209.48
545-BCINT675	4	675	17	20	284.05	267.33

## BC PRO UPS SYSTEMS

### Features:

- Complete protection against blackouts, brownouts, surges, spikes, and EMI/RFI line noise
- Network interface port (D89) allows automatic unattended shutdown of any operating system using PowerAlert software; SNMP manageable
- Diagnostic LEDs alert you to UPS operating conditions
- \$25,000 Ultimate Lifetime Insurance for connected equipment

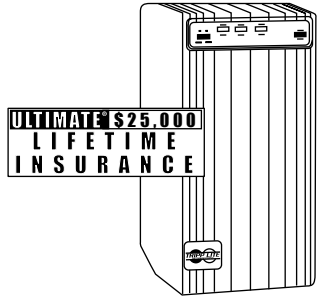

MOUSER STOCK NO.	Outlets	Output VA	Backup Time 1/2 Load (min.)	Weight (lbs)	Price Each	
					1	2
545-450	4	450	17	14.5	189.00	180.00
545-550	4	550	24	19	246.05	227.43
545-675	4	675	17	20	284.05	267.33
545-850	4	850	21	26.5	366.80	352.45
545-1050	6	1050	23	35	426.55	396.34
545-1400	6	1400	24	41.5	540.55	501.41

## INTERNET OFFICE UPS SYSTEMS

### Features:

- 6 outlets (3 UPS and 3 surge-only) protect your entire computer setup—even laser and inkjet printers!
- Complete protection against blackouts, brownouts, surges, spikes, and EMI/RFI line noise
- Dual RJ11 jacks provide superior surge, spike, EMI/RFI protection on your internet connection
- Wide-spaced outlet configuration accepts bulky transformers without blocking remaining outlets
- Internet Office 420 LP features a low-profile, under-monitor housing with front-panel switches for fingertip control over any computer system
- \$25,000 Ultimate Lifetime Insurance coverage for connected equipment

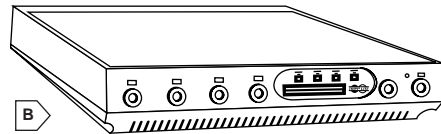
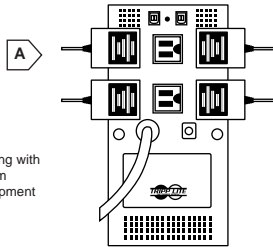

ULTIMATE \$25,000 LIFETIME INSURANCE

MOUSER STOCK NO.	Fig.	Outlets	Output VA	Backup Time 1/2 Load (min.)	Weight (lbs)	Price Each	
						1	2
545-IO325	A	6	325	28	14	166.25	158.27
545-IO450	A	6	450	17	16	179.55	172.90
545-IO420L	B	6	420	17	17	212.80	207.48

## OMNISMART LINE INTERACTIVE UPS SYSTEMS

### Features:

- Automatic Voltage Regulation (AVR) keeps you working through brownouts/overvoltages without using battery power
- Complete protection against blackouts, brownouts, surges, spikes, and EMI/RFI line noise
- Includes PowerAlert Unattended Shutdown Software on CD-ROM and cabling for Windows 95 and most other operating systems
- Diagnostic LEDs alert you to UPS operating condition, battery-charge and load status
- \$50,000 Ultimate Lifetime Insurance covers connected equipment

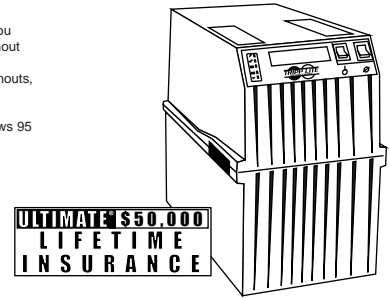

MOUSER STOCK NO.	Outlets	Output VA	Backup Time 1/2 Load (min.)	Weight (lbs)	Price Each	
					1	2
545-OSMART280PNP	4	280	17	13	170.00	155.61
545-OSMART450PNP	4	450	17	15.5	284.00	256.69
545-OSMART675PNP	4	675	17	20.5	350.55	320.63
545-OSMART850PNP	4	850	21	28	445.55	403.80
545-OSMART1050PNP	6	1050	23	37	512.00	463.84
545-OSMART1400PNP	6	1400	21	44	616.55	558.14

## SMARTPRO NET UPS SYSTEMS

### Features:

- Multilevel line-interactive Automatic Voltage Regulation (AVR) lets you work through severe brownouts and overvoltages without using battery power
- Complete protection against blackouts, brownouts, surges, spikes, and EMI/RFI line noise
- Includes PowerAlert Plus software on CD-ROM for unparalleled network UPS management and control
- Diagnostic LEDs alert you to UPS operating condition, battery-charge and load status
- Rackmount (RM) models available
- \$50,000 Ultimate Lifetime Insurance covers connected equipment

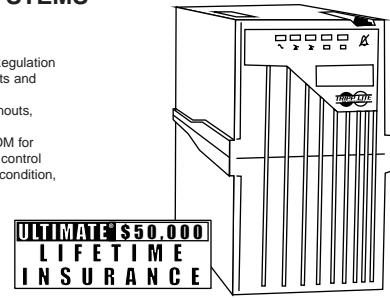

MOUSER STOCK NO.	Outlets	Output VA	Backup Time 1/2 Load (min.)	Weight (lbs)	Price Each	
					1	2
545-SMART450NET	4	450	19	19	350.55	313.65
545-SMART700NET	4	700	20	28	445.55	402.23
545-SMART1050NET	6	1050	23	38	574.54	563.92
545-SMART1050RM	8	1050	23	44	711.55	670.00
545-SMART1400NET	6	1400	25	48	740.00	667.73
545-SMART1400RM	8	1400	26	53	901.55	853.58

## EXTENDED BACKUP UPS SYSTEMS

### Features:

- "Peak Power" performance provides up to 200% of maximum power for short durations, giving adequate power to start AC motors and heavy inductive loads
- Modified sine wave output handles heavy inductive loads
- Use with BP-260 battery case and 98-121 batteries

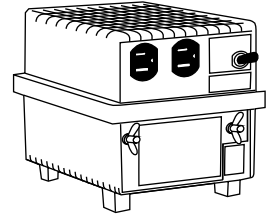

MOUSER STOCK NO.	Outlets	Output VA	Weight (lbs)	Price Each	
				1	2
545-APS400	2	480	16	279.00	248.71
545-APS750	2	900	20	458.00	408.31
545-APS1250	2	1500	39	727.50	672.22

NEW THIS ISSUE NEW THIS ISSUE NEW THIS ISSUE NEW THIS ISSUE NEW THIS ISSUE

# SL WABER® Power Protection Equipment

## POWER MASTER® SURGE AND NOISE SUPPRESSORS

- Electrical rating: 15A 125VAC, 60Hz, 1875W, continuous duty
- Type cord: 14/3 SJT
- Case color: beige
- Rating per UL 1449: 400V (H-N)
- Modes of surge suppression: H-N, H-G, N-G
- Max surge current: 4500A
- Clamping response time: <1 nS.
- Maximum energy dissipation: 90 joules (2x45)
- 1-year limited warranty

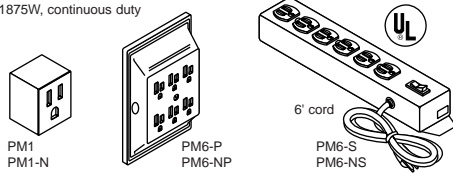

MOUSER STOCK NO.	No. of Outlets	Dimensions (In.)			Unit Shipping Weight	Price Each			
		Length	Width	Height		1	5	10	25
554-PM1	1	1.38	1.38	2.0	2 oz.	9.95	9.45	7.47	Call For Quote
554-PM1-N	1	1.38	1.38	1.25	2 oz.	14.95	14.20	11.25	
554-PM6-P	6	4.84	3.312	1.25	7 1/2 oz.	16.95	16.10	12.72	
554-PM6-NP	6	4.84	3.312	1.25	7 1/2 oz.	17.95	17.05	14.58	Call
554-PM6-S	6	13.25	2.375	1.50	2 1/2 lbs.	19.95	18.95	18.04	
554-PM6-NS	6	13.25	2.375	1.50	2 1/2 lbs.	23.98	22.78	21.58	

## POWER MASTER® WHOLE HOUSE SURGE ARRESTER

- Electrical rating: 15A, 120/240VAC, 60Hz
- Max energy dissipation: 275 joules/phase
- Max surge current: 26,500A
- Case color: beige
- Clamp response time: <1 nS.
- Modes of surge protection: H1-N, H2-N
- 3-year limited warranty

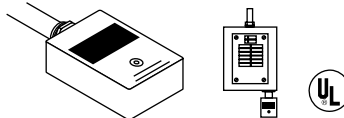

MOUSER STOCK NO.	No. of Outlets	Dimensions (In.)			Unit Shipping Weight	Price Each			
		Length	Width	Height		1	6	12	24
554-WH1	---	3.375	2.25	1.125	1 lb.	69.95	66.45	58.25	Call

## DATAGARD® SERIES

- Protection: 15A circuit breaker
- 3 line voltage surge protection
- Ensures that equipment is isolated from transients on all incoming power lines
- Rating per UL 1449: 400V
- Modes of surge suppression: H-N, H-G, N-G
- Max surge current: 6500A
- Clamping response time: <1 nS.
- Maximum energy dissipation: 210 joules (3x70)

- Case color: beige
- Type cord: 14/3 SJT
- Electrical rating: 15A, 125VAC, 60Hz, 1875W, continuous duty
- Lifetime warranty

MOUSER STOCK NO.	No. of Outlets	Type	Surge Indication	Modes of Noise Rejection	Price Each		
					1	6	12
554-DG204	4	Strip w/6' cord	----	None	24.95	23.70	19.75
554-DG206	6	Strip w/6' cord	----	None	29.95	28.95	23.72
554-DG115-SI	6	Strip w/6' cord	Visual	Transverse	49.95	47.45	39.55
554-DG315-SA	6	Strip w/6' cord	Audible	Transverse & Common	69.95	66.45	58.25

## WAVE TRACKER™ NOISE AND SURGE FILTER

- Maximum ratings: 15A, 125VAC, 60Hz
- Load: 1875W continuous
- Maximum surge voltage: 6,000V
- Clamping response time: 1 psec. (typ.)
- Operating temperature: -13°F to 140°F
- Circuit breaker: 15A
- UL 1449 rating: 330V
- Modes of protection: H-N, H-G, N-G
- Power cord: SJT 14/3
- Noise frequency: 150kHz to 100MHz
- Noise rejection: transverse and common
- NEMA 5-15 plug and receptacles
- Exceeds ANSI/IEEE C62.41-1980 (IEEE 587-1980)

- Audible and visual surge indicators
- Patented 3 stage protection (MOV, Gas Tube, Silicon Avalanche Diode)
- Cord length: 6ft. (except WT2P)
- Color: silver aluminum housing, black receptacles, end caps, and cord
- Lifetime connected equipment warranty



MOUSER STOCK NO.	Fig.	No. of Outlets	Noise Filtration				Max. Energy Dissipation (H-N)	Max. Surge Current (H-N)	Price Each
			1st	2nd	3rd	4th			
554-WT2P	A	2	75dB	----	----	----	485J	33,025A	59.95
554-WT4	B	4	75dB	100dB	----	----	555J	39,525A	94.95
554-WT4M	B	4	75dB	100dB	----	----	555J	39,525A	114.95
554-WT6	B	6	75dB	100dB	110dB	----	625J	46,025A	114.95
554-WT8	B	8	75dB	100dB	110dB	125dB	695J	52,525A	129.95

## UPS SYSTEMS

- Protection against blackouts, brownouts, and high line conditions
- User replacement batteries
- Full recharge time ≤ 2 hours
- Automatic self-testing

### Field Replacement Batteries:

- 554-BP250 for 554-PH250
- 554-BP500 for 554-PH500

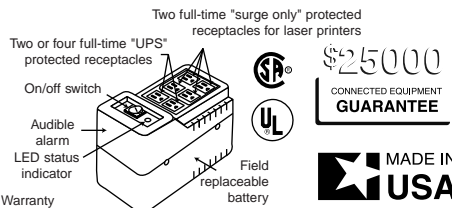

MOUSER STOCK NO.	Description	Weight (Lbs.)	Price Each
554-PH250	250 VA, 4 outlet (2 "UPS", 2 "surge only")	7	149.00
554-PH500	500VA, 6 outlet (4 "UPS", 2 "surge only")	12	299.00

## ECONOMY WABERSTRIP® SERIES OUTLET STRIPS

- Double insulated cord with 3 pronged insulated grounding plug (3ft. 6NX; 4ft. PS6)
- Maximum rating: 15 amps, 125 VAC, 60Hz, 1875 watts
- Warranty: 2 years against defects in materials and workmanship



MOUSER STOCK NO.	Fig.	Color	Master Switch with Pilot LT	Price Each			
				1	6	12	24
554-PS6	A	Beige	No	7.99	7.59	6.82	Call
554-6NX	B	Beige	No	7.95	7.55	6.59	Call

## MULTIPLE OUTLET STRIPS

- Maximum rating: 15A, 125VAC, 60Hz 1875 W, continuous duty
- Outlets: "U" Ground
- Seamless steel case with baked-on finish
- Power cord: 14/3 SJT, molded plug
- † UL Listed    \*UL Listed and CSA Certified

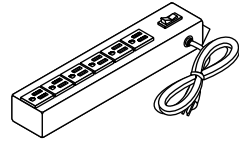

### Compact Series

- Cord length: 6'    • Size: 8 3/4" L x 2 3/8" W x 1 1/2" H    For quantities greater than listed, call for quote.

MOUSER STOCK NO.	No. of Outlets	Master Switch with Pilot LT	Circuit Breaker	Case Color	Price Each		
					1	6	12
554-4SPDX-6	4	Yes	Yes	Beige	13.95	13.25	12.50
554-602	5	No	No	Gray	14.46	13.74	13.45
554-UL602CB-6	5	No	Yes	Blue	21.82	20.73	20.30
554-603CB	4	No	Yes	Gray	18.63	17.70	17.31
554-UL603CB-6	4	No	Yes	Blue	20.66	19.63	19.18
554-UL605CB-6	3	Yes	Yes	Blue	23.50	22.33	21.87

### Mid Length Series

- Cord length: 6'    • Size: 13 1/4" L x 2 3/8" W x 1 1/2" H

MOUSER STOCK NO.	No. of Outlets	Master Switch with Pilot LT	Circuit Breaker	Case Color	Price Each		
					1	6	12
554-6SPDX-6	6	Yes	Yes	Beige	15.95	15.15	14.50
554-UL24CB-6	6	Yes	Yes	Blue	28.57	27.14	26.59

### 90° Design

MOUSER STOCK NO.	No. of Outlets	Master Switch with Pilot LT	Circuit Breaker	Case Color	1	6	12
554-UL24RA-6	6	Yes	Yes	Blue	29.74	28.25	27.71

## TRIMLINE SERIES

- Outlets: "U" ground
- Maximum rating: 15A, 125VAC, 60Hz, 1875W, continuous duty
- Protection: circuit breaker
- Power cord: 14/3 SJT, molded plug
- Cord length: 6 feet
- Case color: blue
- \* Includes mounting tabs

MOUSER STOCK NO.	No. of Outlets	Dimensions (In.)			Key Hole-Slot Mtg. Centers	Price Each		
		L *	W	H		1	6	12
554-UL7208-6	8	25	2	1	22 15/16	43.14	40.98	Call For Quote
554-UL7408-6	8	49	1 1/2	1 3/8	46 15/16	50.90	48.36	
554-UL7415-6	15	49	1 1/2	1 3/8	46 15/16	59.78	56.79	
554-UL7610-6	10	73	1 1/2	1 3/8	70 15/16	60.85	57.81	
554-UL7619-6	19	73	1 1/2	1 3/8	70 15/16	70.95	67.40	

## PERMANENT MOUNTING SERIES Designed for Fixed Installation

- Sizes: 3', 4', 5', 6', lengths x 1 19/32" x 1 3/8"
- Maximum rating: 15A, 125VAC, 60Hz, 1875W, continuous duty
- Outlets: "U" ground, beige
- Case: fabricated with baked-on beige finish
- 1/2" concentric knockouts on each end
- Back cover mounting holes 3/16" dia.
- Wire nuts and self-tapping screws for attachment of top assembly to back mounting cover is provided

MOUSER STOCK NO.	No. of Outlets	Length (Ft.)	Outlet Centers (In.)	No. of Mounting Holes	Price Each		
					1	6	12
554-4305	5	3	7	2	31.55	29.97	Call For Quote
554-4309	9	3	3-1/2	2	34.40	32.68	
554-4407	7	4	7	3	39.28	37.32	
554-4413	13	4	3-1/2	3	43.00	40.85	
554-4508	8	5	7	3	40.78	38.74	
554-4515	15	5	3-1/2	3	47.00	44.65	
554-4610	10	6	7	3	45.22	42.96	
554-4619	19	6	3-1/2	3	56.32	53.50	

## CORDGARD

- Provided with optional double-faced adhesive tape
- Ribbed slots on bottom prevent movement on carpet
- Can be easily trimmed to exact lengths
- Use indoors or outdoors
- Made of tough, flexible vinyl
- Channel pre-slit for easy cord insertion
- Accepts cord diameter up to 7/16" diameter (14/3 SJT cord)

MOUSER STOCK NO.	Color	Length (Ft.)	Price Each			
			1	4	6	12
554-G6-BE	Beige	6	16.95	13.43	11.85	Call For Quote
554-G6-BR	Brown	6	16.95	13.43	11.85	
554-G15-BE	Beige	15	31.95	28.15	25.80	
554-G15-BR	Brown	15	31.95	28.15	25.80	
554-G50-BE	Beige	50	106.95	87.20	79.93	
554-G50-BR	Brown	50	106.95	87.20	79.93	